

AMERICAN F^YRE DESIGNS™

outdoor products collection

AFD PRODUCTS ARE FOR OUTDOOR USE ONLY



CRAFTED WITH PRIDE  IN THE USA

TABLE OF CONTENTS

DESCRIPTION	PAGE
Fireplaces	2-3
Fireplace Accessories	4-5
Chat Height Firetables	6-7
Dining Height Firetables	8
Fire Bowls	9-10
Fire Pits	10
Fire Urns & Lanterns	11
Fyre Glass, Fyre Gems, & Diamond Nuggets	12
Fyre Spheres, Outdoor Gas Logs, Stones, & Lava Media	13
Protective Covers & Tank/End Tables	14
Glass Wind Guards, Conversion Kits, & Repl. Burners	15
Ordering Guide & Warranty Information	16

STEP 1: (Choose a Vented or Vent Free Fireplace)

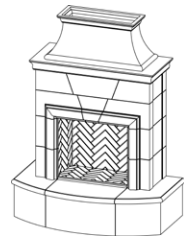
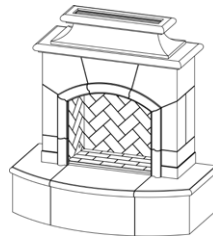
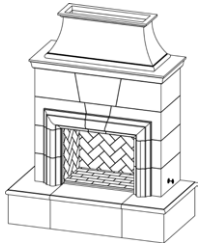

Cordova	
Vented #:	022-XX-X-XX-XXC
Vent-Free #:	122-XX-X-XX-XXC
Dimensions:	76"w x 41"d x 95"h
Wt. (lbs) / Pcs.:	1700 / 11
Vented:	\$10,324
Vent-Free:	\$10,858

Phoenix	
Vented #:	017-XX-X-XX-XXC
Vent-Free #:	117-XX-X-XX-XXC
Dimensions:	65"w x 36"d x 87"h
Wt. (lbs) / Pcs.:	1100 / 7
Vented:	\$6,722
Vent-Free:	\$7,282

Mariposa	
Vented #:	073-XX-X-XX-XXC
Vent-Free #:	173-XX-X-XX-XXC
Dimensions:	65"w x 36"d x 67"h
Wt. (lbs) / Pcs.:	970 / 7
Vented:	\$6,722
Vent-Free:	\$7,282

Petite Cordova	
Vented #:	025-XX-X-XX-XXC
Vent-Free #:	125-XX-X-XX-XXC
Dimensions:	65"w x 36"d x 84"h
Wt. (lbs) / Pcs.:	1100 / 10
Vented:	\$6,722
Vent-Free:	\$7,282

STEP 2: (Choose Hearth Style)

Compatible Hearths for Cordova

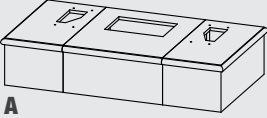
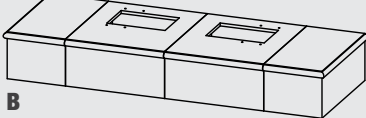
			
A	B		
HEARTH DESCRIPTION	DIMENSIONS	MODEL #	PRICE
A 16" Rectangle Bullnose	76"w x 41"d x 16"h	xxx-20-x-xx-xxC	N/C
B 110" Rectangle Extended Bullnose	110"w x 41"d x 16"h	xxx-35-x-xx-xxC	\$857

Compatible Hearths for Phoenix, Mariposa & Petite Cordova

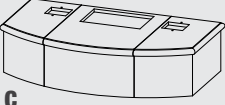
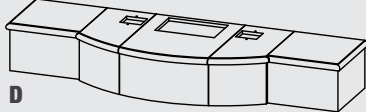
			
C	D		
HEARTH DESCRIPTION	DIMENSIONS	MODEL #	PRICE
C 16" Radiused Bullnose	65"w x 36"d x 16"h	xxx-01-x-xx-xxC	N/C
D 113" Extended Bullnose	113"w x 36"d x 16"h	xxx-05-x-xx-xxC	\$736

All Fireplaces shown and weighed with 16" standard hearth. Extended hearths add **two additional** pieces to the total count.

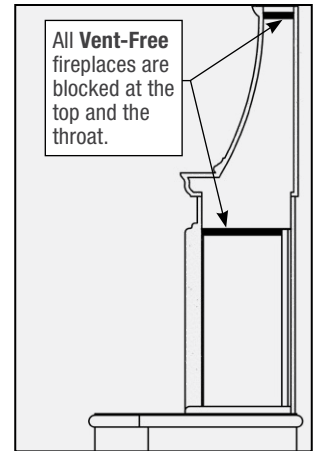

Vent-Free Fireplaces are **certified** to go under a covered area.

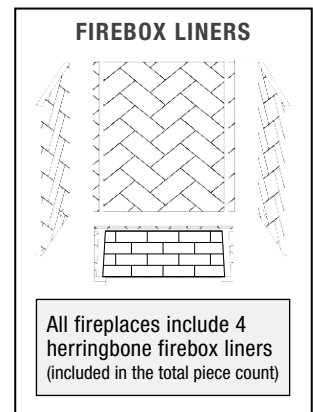

STEP 3: (Choose Recess Option)

2" RECESS OPTIONS for above Fireplaces & Hearths

No Recess	xxx-xx- N -xx-xxC	N/C
Hearth Only	xxx-xx- H -xx-xxC	\$523
Hearth & Body	xxx-xx- A -xx-xxC	523

Fireplaces may be ordered with **recessed** hearth and/or body to accommodate field cladding in tile, stone or other veneer.

STEP 1 & 2

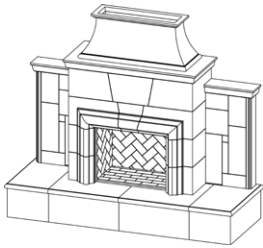

Grand Cordova (w/ Rectangle Extended Bullnose Hearth)	
Vented #:	882-35-X-XX-XXC
Vent-Free #:	182-35-X-XX-XXC
Dimensions:	110"w x 41"d x 95"h
Wt. (lbs) / Pcs.:	1900 / 13
Vented:	\$13,563
Vent-Free:	\$14,165

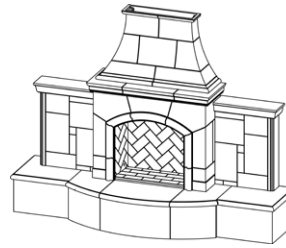

Grand Phoenix (w/ Extended Bullnose Hearth)	
Vented #:	818-05-X-XX-XXC
Vent-Free #:	118-05-X-XX-XXC
Dimensions:	113"w x 36"d x 87"h
Wt. (lbs) / Pcs.:	1400 / 15
Vented:	\$10,324
Vent-Free:	\$10,925

STEP 3

RECESS OPTIONS for above Fireplaces & Hearths

No Recess	XXX-XX- N -XX-XXC	N/C
Hearth Only	XXX-XX- H -XX-XXC	\$523

Grand Fireplaces may be ordered with **recessed** hearth to accommodate field cladding in tile, stone or other veneer.

STEP 1, 2, & 3

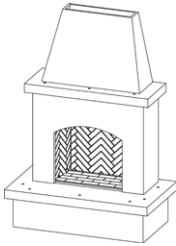

Contractor's Model	
Vented #:	040-11-A-WC-RBC
Vent-Free #:	140-11-A-WC-RBC
Dimensions:	67"w x 37"d x 96"h
Wt. (lbs) / Pcs.:	810 / 9
Vented:	\$4,462
Vent-Free:	\$5,052

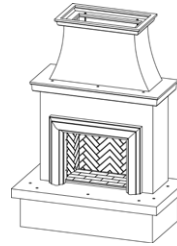

Contractor's Model with Moulding	
Vented #:	045-11-A-WC-RBC
Vent-Free #:	145-11-A-WC-RBC
Dimensions:	67"w x 37"d x 91"h
Wt. (lbs) / Pcs.:	810 / 9
Vented:	\$5,052
Vent-Free:	\$5,640

Note: Contractor's Model Fireplaces come in **White (GFRC) finish only**, recessed to accommodate field cladding, and with the key/gas location on the right out the back only.

STEP 1, 2, & 3



Milan Tall Linear Fireplace *	
Model #:	211-TA-N-XX-M8xC
Dimensions:	72"w x 16"d x 60"h
Wt. (lbs) / Pcs.:	730 / 9
Price:	\$9,033

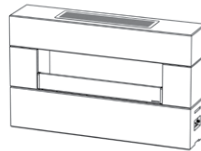

Milan Low Linear Fireplace *	
Model #:	211-LO-N-XX-M8xC
Dimensions:	72"w x 16"d x 44"h
Wt. (lbs) / Pcs.:	560 / 8
Price:	\$7,405

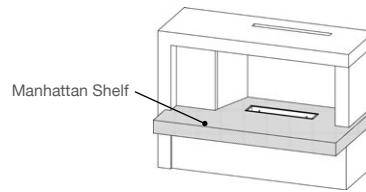

Manhattan (w/ Mirror Stainless Steel Liner)	
Model #:	082-xx-N-XX-M3NC
Dimensions:	59"w x 32"d x 42"h
Wt. (lbs) / Pcs.:	750 / 8
Price:	\$7,993

The Manhattan comes with a Natural Gas burner. For Propane change the **next to last** digit from an "N" to a "P". Manhattan Propane version has access door to house a Propane tank.

MANHATTAN ONLY

SHELF COLOR	MODEL #
White Aspen	XXX- WA -X-XX-XXXC
Café Blanco	XXX- CB -X-XX-XXXC
Black Lava	XXX- BA -X-XX-XXXC
Smoke	XXX- SM -X-XX-XXXC
Smooth Black	XXX- SB -X-XX-XXXC

To select the body color turn to page 4.

w/ FyreStarter Ignition System †	
Model #:	211-TA-N-XX-H8xC
Price:	\$11,481

w/ FyreStarter Ignition System †	
Model #:	211-LO-N-XX-H8xC
Price:	\$9,853

-Optional vinyl cover: 8145A

-Optional vinyl cover: 8145A

FIREPLACE VALVES

VALVE	DESCRIPTION	GAS	BTU's
M3	Linear Burner	NG	40k
	Linear Burner	LP	40k
M8	48" Linear Burner	NG	65k
	48" Linear Burner	LP	65k
H8	48" Burner w/ FyreStarter	NG	100k
	48" Burner w/ FyreStarter	LP	100k

M-series valves now include a spark igniter.

* Cannot accommodate an LP tank inside the unit; selecting Propane may require Tank/End Table and Hose (see page 14).

† FyreStarter = Bluetooth remote control, requires 120 Volt AC Power. Includes **A** and **C** USB ports.

STEP 4: (Choose Finish)

FINISH COLORS	MODEL #
White Aspen	XXX-XX-X- WA -XXC
Café Blanco	XXX-XX-X- CB -XXC
Black Lava	XXX-XX-X- BA -XXC
Smoke	XXX-XX-X- SM -XXC

ANTIQUÉ FINISHES	MODEL #
Travertine	XXX-XX-X- TR -XXC
Dark Basalt	XXX-XX-X- DB -XXC
Light Basalt	XXX-XX-X- LB -XXC

Milan Linear Fireplaces Only
(In addition to the standard Finish Colors)

- American Fyre Designs™ products are individually handcrafted, the finishes listed are subject to slight texture and color variation.
- American Fyre Designs™ reserves the right to change or discontinue finishes without prior notice. Samples available upon request.
- Contractor's Model Fireplaces are only available in **White (WC)** GFRC finish.

STEP 5: (Choose Gas Shut Off & Line Location)

GAS SHUT OFF & LINE LOCATION	MODEL #
Key Valve on the RIGHT / Gas Source out the BACK	XXX-XX-X-XX- RBC

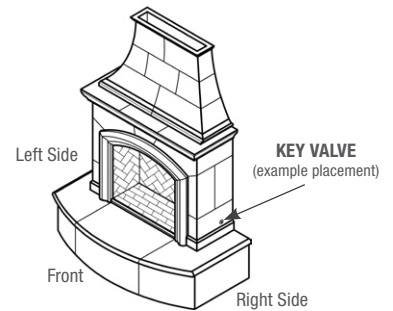

Note: All Fireplaces are crated for shipment.

Fireplace Accessories

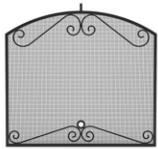

Arched Black Scroll Screen
Model #: 8250-BL
Price: \$636
Compatible Fireplaces: <ul style="list-style-type: none"> Phoenix Grand Phoenix Mariposa

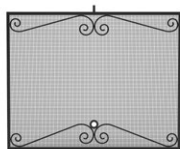

Black Scroll Screen
Model #: 8255-BL
Price: \$797
Compatible Fireplaces: <ul style="list-style-type: none"> Cordova Grand Cordova

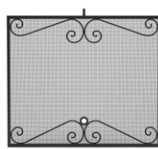

Black Scroll Screen
Model #: 8253-BL
Price: \$636
Compatible Fireplaces: <ul style="list-style-type: none"> Petite Cordova



GFRC Chimney Rain Vent Cap
Model #: 8017RV-XX
Price: \$293
Compatible Fireplaces: <ul style="list-style-type: none"> Phoenix Grand Phoenix



GFRC Chimney Rain Vent Cap
Model #: 8073RV-XX
Price: \$308
Compatible Fireplaces: <ul style="list-style-type: none"> Mariposa



Arched GFRC Protector Plate
Model #: 8200-XX
Price: \$416
Compatible Fireplaces: <ul style="list-style-type: none"> Phoenix Grand Phoenix Mariposa



GFRC Protector Plate
Model #: 8210-XX
Price: \$430
Compatible Fireplaces: <ul style="list-style-type: none"> Cordova Grand Cordova



GFRC Protector Plate
Model #: 8205-XX
Price: \$416
Compatible Fireplaces: <ul style="list-style-type: none"> Petite Cordova



GFRC Chimney Rain Vent Cap
Model #: 8022RV-XX
Price: \$319
Compatible Fireplaces: <ul style="list-style-type: none"> Cordova Grand Cordova



GFRC Chimney Rain Vent Cap
Model #: 8025RV-XX
Price: \$308
Compatible Fireplaces: <ul style="list-style-type: none"> Petite Cordova

"-xx" = Insert color code from **STEP 4** above.

STEP 6: (Choose Media Type & Corresponding Burner)

Vented & Vent Free Log Sets For Fireplaces

STYLE	MODEL #	16"	18/20"	24"	30"
Charred Oak (Vented)	CHD-xx	\$382 28#	\$431 46#	\$506 62#	\$676 78#



STYLE	MODEL #	16/20"	24"	30"
Charred Frontier Oak (Vent-Free)	CHFR-xx	\$364 35#	\$416 41#	\$517 48#



"-xx" = insert size

For a complete listing of Real Fyre® Vented and Vent-Free log sets see the Real Fyre® Price Lists **L-A3-02124** and **L-F3-02224**.

Glass, Gems, & Nuggets

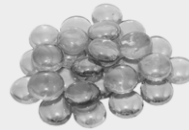

See page 12 for packages, colors, and pricing.

Recommendation: One 10 lb package to fill burner pan. If your desire is to fill fireplace at a 2" depth use one 10 lb bag for every 65 sq. inches 25 lbs is recommended for the Manhattan style fireplace.

Stainless Steel Vented & Vent-Free Burner Systems for Fireplaces

VENTED BURNERS	STYLE	MODEL #	16"	18/20"	24"	30"
G45 Vented Stainless Steel Burner (LOGS)	Standard	G45-xx-SS (Natural gas only)	\$416 25#	\$439 27#	\$470 31#	\$541 37#
	Standard with Assembled Valve	G45-xxNA-SS or G45-xxPA-SS	\$789 27#	\$812 29#	\$843 33#	\$914 39#
G45 Vented Stainless Steel Burner (GLASS/GEMS)	Standard	G45-GL-xx-SS (Natural gas only)	\$394 20#	\$415 22#	\$441 28#	\$510 31#
	Standard with Assembled Valve	G45-GL-xxNA-SS or G45-GL-xxPA-SS	\$767 22#	\$788 24#	\$814 30#	\$883 33#



VENTED FIREPLACE / BURNER SIZE COMPATIBILITY

Vented Fireplaces	G45 Burner		G22 Burner	
	Match-Lit	w/ Valve	Match-Lit	w/ Valve
022, 882	up to 30"	up to 24"	up to 30"	up to 24"
017, 818, 073, 025, 040, 045	up to 24"	up to 18/20"	up to 24"	up to 18"

VENT-FREE BURNERS	STYLE	MODEL #	16/18"	24/30"
G10 Vent-Free Stainless Steel Burner (LOGS) 16/18" 22-25# 24/30" 26-30#	Manual	G10-xx-SS	\$1,510	\$1,621
	Variable Remote *	G10-xx-15-SS	\$1,983	\$2,094
	Electronic Remote *	G10-xx-01V-SS	\$2,368	\$2,479

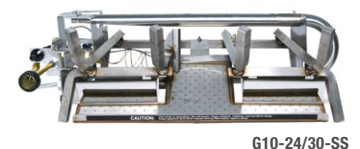

VENT-FREE BURNERS	STYLE	MODEL #	18"	24"	30"
G21 Vent-Free Contemporary Burner (GLASS/GEMS) 20-30#	Remote *	G21-GL-xx-12	\$1,486	\$1,602	\$1,670



VENT-FREE FIREPLACE / BURNER SIZE COMPATIBILITY

Vent-free Fireplaces	G10 Burner	G21 Burner
122, 182	up to 24/30" w/ 30" log	up to 30"
117, 118, 173, 125, 140, 145	up to 24/30" w/ 24" log	up to 24"

* Remote systems include basic Transmitter and Receiver.

"-xx" = insert size

STEP 1: Choose Product - Chat Height Firetables

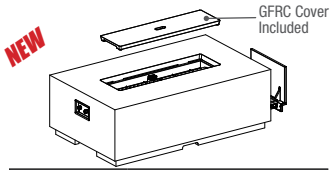

Legend LP Select	
Model #:	585-xx-11-M7PC
Dimensions:	60" w x 36" d x 20" h
Weight (lbs):	420
Price:	\$4,726

-Horizontal LP tank not included
-Optional vinyl cover: 8152A

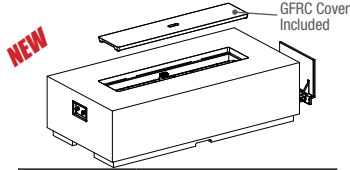

Legend Long LP Select	
Model #:	587-xx-11-M8PC
Dimensions:	72" w x 36" d x 20" h
Weight (lbs):	490
Price:	\$5,759

-Horizontal LP tank not included
-Optional vinyl cover: 8153A

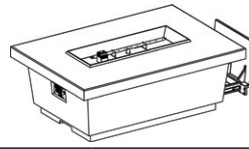

Contempo LP Select	
Model #:	785-xx-11-M4PC
Dimensions:	52" w x 36" d x 18½" h
Weight (lbs):	393
Price:	\$3,760

-Horizontal LP tank not included
-Optional vinyl cover: 8139A

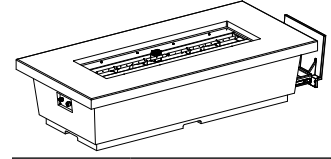

Contempo Long LP Select	
Model #:	788-xx-11-M8PC
Dimensions:	76" w x 36" d x 18½" h
Weight (lbs):	470
Price:	\$5,614

-Horizontal LP tank not included
-Optional vinyl cover: 8155A

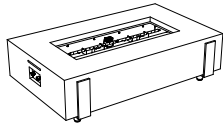

Iron Saddle Firetable *	
Model #:	580-xx-11-M7xC
Dimensions:	60" w x 36" d x 17" h
Weight (lbs):	370
Price:	\$5,129

w/ FyreStarter Ignition System †	
Model #:	580-xx-11-H7xC
Price:	\$7,601

-Optional vinyl cover: 8152A

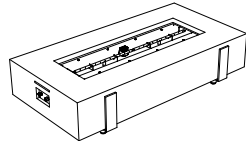

Iron Saddle Long Firetable *	
Model #:	588-xx-11-M8xC
Dimensions:	72" w x 36" d x 17" h
Weight (lbs):	486
Price:	\$6,175

w/ FyreStarter Ignition System †	
Model #:	588-xx-11-H8xC
Price:	\$8,684

-Optional vinyl cover: 8153A

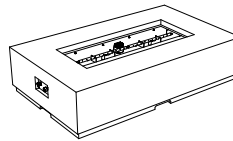

Legend Firetable *	
Model #:	581-xx-11-M7xC
Dimensions:	60" w x 36" d x 14½" h
Weight (lbs):	395
Price:	\$3,976

w/ FyreStarter Ignition System †	
Model #:	581-xx-11-H7xC
Price:	\$6,448

-Optional vinyl cover: 8152A

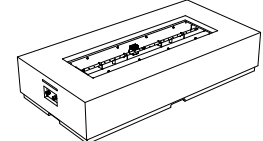

Legend Long Firetable *	
Model #:	589-xx-11-M8xC
Dimensions:	72" w x 36" d x 14½" h
Weight (lbs):	402
Price:	\$5,023

w/ FyreStarter Ignition System †	
Model #:	589-xx-11-H8xC
Price:	\$7,532

-Optional vinyl cover: 8153A

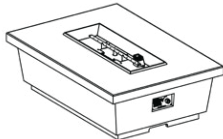

Contempo Rectangle **	
Model #:	783-xx-11-M4xC
Dimensions:	52" w x 36" d x 15½" h
Weight (lbs):	230
Price:	\$3,309

w/ FyreStarter Ignition System †	
Model #:	783-xx-11-H4xC
Price:	\$5,781

-Optional vinyl cover: 8139A

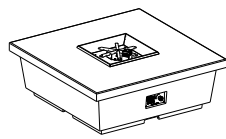

Contempo Square **	
Model #:	784-xx-11-M2xC
Dimensions:	44" w x 44" d x 15½" h
Weight (lbs):	230
Price:	\$3,460

w/ FyreStarter Ignition System †	
Model #:	784-xx-11-H2xC
Price:	\$5,932

-Optional vinyl cover: 8146A

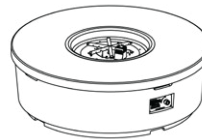

Contempo Round **	
Model #:	782-xx-11-M2xC
Dimensions:	47" dia x 15½" h
Weight (lbs):	200
Price:	\$3,313

w/ FyreStarter Ignition System †	
Model #:	782-xx-11-H2xC
Price:	\$5,785

-Optional vinyl cover: 8143A

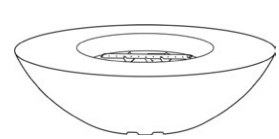

Calais Oval Firetable *	
Model #:	759-xx-11-M4xC
Dimensions:	60" w x 36" d x 18" h
Weight (lbs):	240
Price:	\$4,688

w/ FyreStarter Ignition System †	
Model #:	759-xx-11-H4xC
Price:	\$7,160

-Optional vinyl cover: 8151A



Cosmopolitan Rectangle	
Model #:	635-xx-11-M4xC
Dimensions:	54" w x 36" d x 24" h
Weight (lbs):	220
Price:	\$3,354

w/ FyreStarter Ignition System †	
Model #:	635-xx-11-H4xC
Price:	\$5,826

-Optional vinyl cover: 8138A



Cosmopolitan Square	
Model #:	640-xx-11-M2xC
Dimensions:	36" w x 36" d x 24" h
Weight (lbs):	160
Price:	\$3,034

w/ FyreStarter Ignition System †	
Model #:	640-xx-11-H2xC
Price:	\$5,506

-Optional vinyl cover: 8132A



Cosmopolitan Round	
Model #:	645-xx-11-M2xC
Dimensions:	48" dia x 24" h
Weight (lbs):	210
Price:	\$3,604

w/ FyreStarter Ignition System †	
Model #:	645-xx-11-H2xC
Price:	\$6,076

-Optional vinyl cover: 8135A

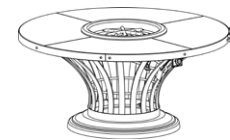

Fiesta Firetable	
Model #:	770-xx-11-M2xC
Dimensions:	54" dia x 25" h
Weight (lbs):	280
Price:	\$3,593

-Optional vinyl cover: 8131A
-Includes nylon cover for Propane tank

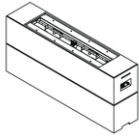

Milan Tall Linear Firetable *	
Model #:	215-xx-11-M8xC
Dimensions:	72" w x 16" d x 32" h
Weight (lbs):	360
Price:	\$4,307

w/ FyreStarter Ignition System †	
Model #:	215-xx-11-H8xC
Price:	\$6,779

-Optional vinyl cover: 8144A

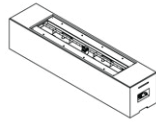

Milan Low Linear Firetable *	
Model #:	216-xx-11-M8xC
Dimensions:	72" w x 16" d x 16" h
Weight (lbs):	215
Price:	\$2,614

w/ FyreStarter Ignition System †	
Model #:	216-xx-11-H8xC
Price:	\$5,086



Voro Firetable	
Model #:	725-xx-11-M2xC
Dimensions:	36" w x 36" d x 24" h
Weight (lbs):	190
Price:	\$3,691

-Optional vinyl cover: 8132A



Voro Cube	
Model #:	726-xx-11-M2xC
Dimensions:	25½" w x 25½" d x 22¾" h
Weight (lbs):	170
Price:	\$3,420

Reclaimed Wood Chat Height Firetables

Reclaimed Wood Firetables feature two (2) table top options, **French Barrel Oak (FO)** and **Silver Pine (SP)**, plus bases with Black Lava (BA) finish. Must select either **French Barrel Oak** (e.g. 635-BA-**FO**-M4xC) or **Silver Pine** (e.g. 635-BA-**SP**-M4xC).

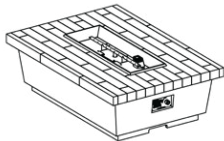

Reclaimed Wood Contempo Rectangle **	
FO Model #:	783-BA-FO-M4xC
SP Model #:	783-BA-SP-M4xC
Dimensions:	54" w x 36" d x 15½" h
Weight (lbs):	230
Price:	\$4,011

w/ FyreStarter Ignition System †	
FO Model #:	783-BA-FO-H4xC
SP Model #:	783-BA-SP-H4xC
Price:	\$6,483

-Optional vinyl cover: 8139A

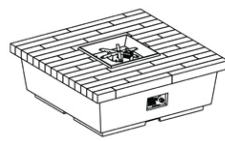

Reclaimed Wood Contempo Square **	
FO Model #:	784-BA-FO-M2xC
SP Model #:	784-BA-SP-M2xC
Dimensions:	44" w x 44" d x 15½" h
Weight (lbs):	230
Price:	\$4,168

w/ FyreStarter Ignition System †	
FO Model #:	784-BA-FO-H2xC
SP Model #:	784-BA-SP-H2xC
Price:	\$6,640

-Optional vinyl cover: 8146A

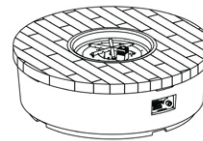

Reclaimed Wood Contempo Round **	
FO Model #:	782-BA-FO-M2xC
SP Model #:	782-BA-SP-M2xC
Dimensions:	47" dia x 15½" h
Weight (lbs):	200
Price:	\$3,850

w/ FyreStarter Ignition System †	
FO Model #:	782-BA-FO-H2xC
SP Model #:	782-BA-SP-H2xC
Price:	\$6,322

-Optional vinyl cover: 8143A

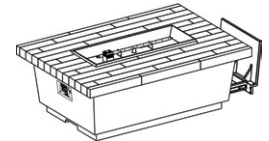

Recl. Wood Contempo LP Select (w/ Drawer to house horizontal LP Tank)	
FO Model #:	785-BA-FO-M4PC
SP Model #:	785-BA-SP-M4PC
Dimensions:	52" w x 36" d x 18½" h
Weight (lbs):	393
Price:	\$4,470

-Horizontal LP tank not included
-Optional vinyl cover: 8139A



Reclaimed Wood Cosmopolitan Rectangle	
FO Model #:	635-BA-FO-M4xC
SP Model #:	635-BA-SP-M4xC
Dimensions:	54" w x 36" d x 24" h
Weight (lbs):	220
Price:	\$4,136

w/ FyreStarter Ignition System †	
FO Model #:	635-BA-FO-H4xC
SP Model #:	635-BA-SP-H4xC
Price:	\$6,608

-Optional vinyl cover: 8138A

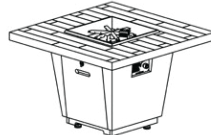

Reclaimed Wood Cosmopolitan Square	
FO Model #:	640-BA-FO-M2xC
SP Model #:	640-BA-SP-M2xC
Dimensions:	36" w x 36" d x 24" h
Weight (lbs):	160
Price:	\$3,577

w/ FyreStarter Ignition System †	
FO Model #:	640-BA-FO-H2xC
SP Model #:	640-BA-SP-H2xC
Price:	\$6,049

-Optional vinyl cover: 8132A



Reclaimed Wood Cosmopolitan Round	
FO Model #:	645-BA-FO-M2xC
SP Model #:	645-BA-SP-M2xC
Dimensions:	48" dia x 24" h
Weight (lbs):	210
Price:	\$4,235

w/ FyreStarter Ignition System †	
FO Model #:	645-BA-FO-H2xC
SP Model #:	645-BA-SP-H2xC
Price:	\$6,707

-Optional vinyl cover: 8135A

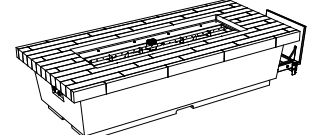

Recl. Wood Contempo LP Select Long (w/ Drawer to house horizontal LP Tank)	
FO Model #:	788-BA-FO-M8PC
SP Model #:	788-BA-SP-M8PC
Dimensions:	76" w x 36" d x 18½" h
Weight (lbs):	573
Price:	\$6,750

-Horizontal LP tank not included
-Optional vinyl cover: 8155A

ORDERING NOTES:

1. "-xx" = Insert color from **STEP 2** on page 8.
2. * Cannot accommodate an LP tank inside the unit; selecting Propane may require Tank/End Table and Hose (see page 14).
3. ** All 782, 783, & 784 models for Propane include **5110-26** 10' Gas Hose.
4. † **FyreStarter** = Bluetooth remote control, requires 120 Volt AC Power. Includes A and C USB ports.
5. **Fire Media sold separately!** See pages 12 & 13 for available Fyre Glass, gas logs & lava fyre options.

Dining Height Firetables

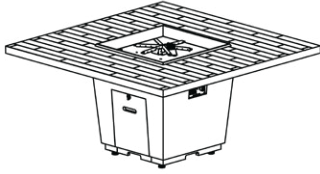

Reclaimed Wood Cosmopolitan Square Dining Firetable

FO Model #: **642-BA-FO-M6xC**

SP Model #: **642-BA-SP-M6xC**

Dimensions: 60" w x 60" d x 29" h

Weight (lbs): 360

Price: **\$7,446**

w/ FyreStarter Ignition System †

FO Model #: **642-BA-FO-H6xC**

SP Model #: **642-BA-SP-H6xC**

Price: **\$9,918**

-Optional vinyl cover: 8137A

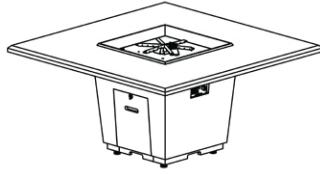

Cosmopolitan Square Dining Firetable

Model #: **642-xx-11-M6xC**

Dimensions: 60" w x 60" d x 29" h

Weight (lbs): 360

Price: **\$6,483**

w/ FyreStarter Ignition System †

Model #: **642-xx-11-H6xC**

Price: **\$8,955**

-Optional vinyl cover: 8137A

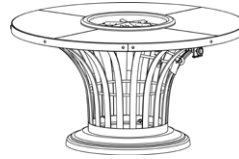

Fiesta Dining Firetable

Model #: **775-xx-11-M2xC**

Dimensions: 54" dia x 28" h

Weight (lbs): 290

Price: **\$4,011**

-Includes nylon cover for Propane tank

-Optional vinyl cover: 8131A

FIRETABLE VALVES

VALVE	DESCRIPTION	GAS	BTU's
M2	12" Star Burner	NG	60k
	12" Star Burner	LP	60k
H2	12" Star Burner w/ FyreStarter	NG	65k
	12" Star Burner w/ FyreStarter	LP	65k
M4	24" Linear Burner	NG	60k
	24" Linear Burner	LP	60k
H4	24" Linear Burner w/ FyreStarter	NG	65k
	24" Linear Burner w/ FyreStarter	LP	65k
M6	16" Star Burner	NG	65k
	16" Star Burner	LP	65k
H6	16" Star Burner w/ FyreStarter	NG	75k
	16" Star Burner w/ FyreStarter	LP	75k
M7	36" Linear Burner	NG	65k
	36" Linear Burner	LP	65k
H7	36" Linear Burner w/ FyreStarter	NG	75k
	36" Linear Burner w/ FyreStarter	LP	75k
M8	48" Linear Burner	NG	65k
	48" Linear Burner	LP	65k
H8	48" Linear Burner w/ FyreStarter	NG	100k
	48" Linear Burner w/ FyreStarter	LP	100k

M-series valves now include a **spark igniter**.

ORDERING NOTES:

1. "-xx" = insert color from **STEP 2**.
2. † **FyreStarter** = Bluetooth remote control, requires 120 Volt AC Power. Includes **A** and **C** USB ports.
3. **Fire Media sold separately!** See pages 12 & 13 for available Fyre Glass, gas logs & lava fyre options.

STEP 2: Choose Color Option(s)

FINISH COLORS	MODEL #
White Aspen	xxx- WA -xx-xxxC
Café Blanco	xxx- CB -xx-xxxC
Black Lava	xxx- BA -xx-xxxC
Smoke	xxx- SM -xx-xxxC

ANTIQUÉ FINISHES	MODEL #
Travertine	xxx- TR -xx-xxxC
Dark Basalt	xxx- DB -xx-xxxC
Light Basalt	xxx- LB -xx-xxxC

- American Fyre Designs™ products are individually handcrafted, the finishes listed are subject to slight texture and color variation.
- American Fyre Designs™ reserves the right to change or discontinue finishes without prior notice. Samples available upon request.

STEP 3: Choose Gas Option

GAS OPTIONS	MODEL #
Natural Gas	xxx-xx-xx-xx NC
Propane Gas	xxx-xx-xx-xx PC

Note: All Firetables, Fire Bowls, & Fire Pits are crated for shipment.

Fire Bowls

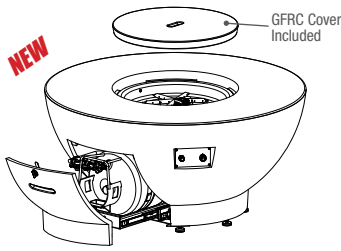

48" Chat Fire Bowl (L.P.)	
Model #:	738-xx-11-M2PC
Dimensions:	48" dia x 23"h
Weight (lbs):	400
Price:	\$4,441

w/ FyreStarter Ignition System †	
Model #:	738-xx-11-H2PC
Price:	\$6,913

-LP units include a tank drawer to accommodate a DOT horizontal tank (tank not included)
-Optional vinyl cover: 8135A

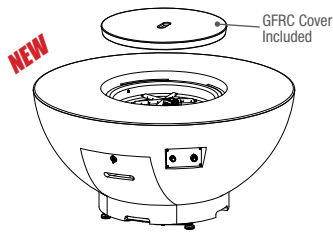

48" Chat Fire Bowl (N.G.)	
Model #:	738-xx-11-M2NC
Dimensions:	48" dia x 23"h
Weight (lbs):	400
Price:	\$3,990

w/ FyreStarter Ignition System †	
Model #:	738-xx-11-H2NC
Price:	\$6,463

-Optional vinyl cover: 8135A

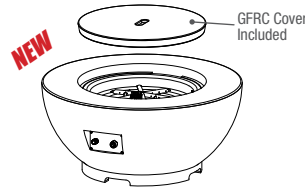

36" Chat Fire Bowl *	
Model #:	736-xx-11-M2xC
Dimensions:	36" dia x 16½"h
Weight (lbs):	200
Price:	\$3,151

w/ FyreStarter Ignition System †	
Model #:	736-xx-11-H2xC
Price:	\$5,551

-Optional vinyl cover: 8140A

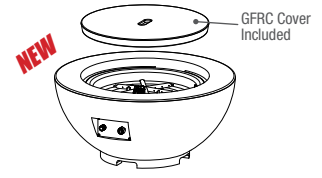

32" Chat Fire Bowl *	
Model #:	735-xx-11-M2xC
Dimensions:	32" dia x 15"h
Weight (lbs):	170
Price:	\$2,969

w/ FyreStarter Ignition System †	
Model #:	735-xx-11-H2xC
Price:	\$5,369

-Optional vinyl cover: 8142A

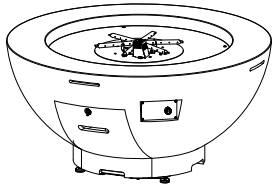

48" Fire Bowl	
Model #:	731-xx-11-M6xC
Dimensions:	48" dia x 22"h
Weight (lbs):	250
Price:	\$3,829

w/ FyreStarter Ignition System †	
Model #:	731-xx-11-H6xC
Price:	\$6,301

-Optional vinyl cover: 8135A

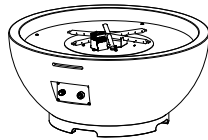

36" Fire Bowl *	
Model #:	732-xx-11-M6xC
Dimensions:	36" dia x 16"h
Weight (lbs):	154
Price:	\$2,718

w/ FyreStarter Ignition System †	
Model #:	732-xx-11-H6xC
Price:	\$5,190

-Optional vinyl cover: 8140A

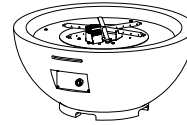

32" Fire Bowl *	
Model #:	733-xx-11-M6xC
Dimensions:	32" dia x 16"h
Weight (lbs):	109
Price:	\$2,549

w/ FyreStarter Ignition System †	
Model #:	733-xx-11-H6xC
Price:	\$5,021

-Optional vinyl cover: 8142A

FIRE BOWL VALVES

VALVE	DESCRIPTION	GAS	BTU's
M2	12" Star Burner	NG	60k
	12" Star Burner	LP	60k
H2	12" Star Burner w/ FyreStarter	NG	65k
	12" Star Burner w/ FyreStarter	LP	65k
M4	24" Linear Burner	NG	60k
	24" Linear Burner	LP	60k
H4	24" Linear Burner w/ FyreStarter	NG	65k
	24" Linear Burner w/ FyreStarter	LP	65k
M6	16" Star Burner	NG	65k
	16" Star Burner	LP	65k
H6	16" Star Burner w/ FyreStarter	NG	100k
	16" Star Burner w/ FyreStarter	LP	100k

M-series valves now include a spark igniter.

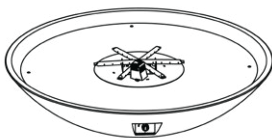

48" Marseille Fire Bowl *	
Model #:	751-xx-11-M6xC
Dimensions:	48" dia x 10½"h
Weight (lbs):	195
Price:	\$2,857

w/ FyreStarter Ignition System †	
Model #:	751-xx-11-H6xC
Price:	\$5,329

with Water Spout	
Model #:	751-xx-80-M6xC
Price:	\$3,355

-Optional vinyl cover: 8143A

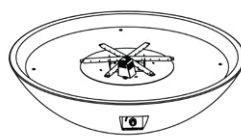

40" Marseille Fire Bowl *	
Model #:	752-xx-11-M6xC
Dimensions:	40" dia x 10½"h
Weight (lbs):	150
Price:	\$2,439

w/ FyreStarter Ignition System †	
Model #:	752-xx-11-H6xC
Price:	\$4,911

with Water Spout	
Model #:	752-xx-80-M6xC
Price:	\$2,937

-Optional vinyl cover: 8140A

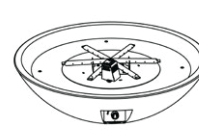

32" Marseille Fire Bowl *	
Model #:	753-xx-11-M6xC
Dimensions:	32" dia x 8½"h
Weight (lbs):	90
Price:	\$2,159

with Water Spout	
Model #:	753-xx-80-M6xC
Price:	\$2,659

-Optional vinyl cover: 8142A

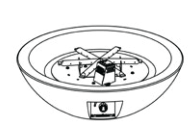

24" Marseille Fire Bowl *	
Model #:	755-xx-11-M2xC
Dimensions:	24" dia x 6½"h
Weight (lbs):	45
Price:	\$1,879

Note: Bowls with Water Spouts are **not available** with FyreStarter ignition.

ORDERING NOTES:

1. "-xx" = Insert color from STEP 2 on page 11.
2. * Cannot accommodate an LP tank inside the unit; selecting Propane may require Tank/End Table and Hose (see page 14).
3. † FyreStarter = Bluetooth remote control, requires 120 Volt AC Power. Includes **A** and **C** USB ports.
4. Fire Media sold separately! See pages 12 & 13 for available Fyre Glass, gas logs & lava fyre options.

Fire Bowls

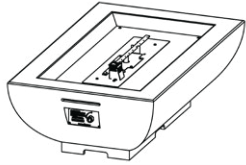

Bordeaux Rectangle Fire Bowl*	
Model #:	435-xx-11-M4xC
Dimensions:	50"w x 30"d x 16¼"h
Weight (lbs):	205
Price:	\$4,107

w/ FyreStarter Ignition System †	
Model #:	435-xx-11-H4xC
Price:	\$6,579

-Optional vinyl cover: 8148A



Bordeaux Square Fire Bowl*	
Model #:	430-xx-11-M6xC
Dimensions:	36"w x 36"d x 15¼"h
Weight (lbs):	180
Price:	\$3,409

w/ FyreStarter Ignition System †	
Model #:	430-xx-11-H6xC
Price:	\$5,881

-Optional vinyl cover: 8132A



Bordeaux Petite Square Fire Bowl*	
Model #:	431-xx-11-M6xC
Dimensions:	30"w x 30"d x 12¼"h
Weight (lbs):	140
Price:	\$3,128

-Optional vinyl cover: 8132A



Reclaimed Wood Bordeaux Square Fire Bowl*	
FO Model #:	430-FO-FO-M6xC
SP Model #:	430-SP-SP-M6xC
Dimensions:	36"w x 36"d x 15¼"h
Weight (lbs):	180
Price:	\$4,107

w/ FyreStarter Ignition System †	
FO Model #:	430-FO-FO-H6xC
SP Model #:	430-SP-SP-H6xC
Price:	\$6,579

-Optional vinyl cover: 8132A

Fire Pits

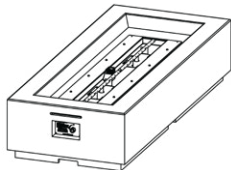

Louvre Long Rectangle Fire Pit*	
Model #:	688-xx-11-M8xC
Dimensions:	72¼"w x 30¼"d x 15¼"h
Weight (lbs):	260
Price:	\$4,684

w/ FyreStarter Ignition System †	
Model #:	688-xx-11-H8xC
Price:	\$7,156

-Optional vinyl cover: 8149A

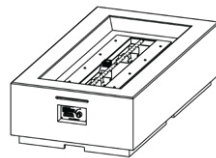

Louvre Rectangle Fire Pit*	
Model #:	689-xx-11-M7xC
Dimensions:	56¼"w x 30¼"d x 15¼"h
Weight (lbs):	215
Price:	\$4,110

w/ FyreStarter Ignition System †	
Model #:	689-xx-11-H7xC
Price:	\$6,582

-Optional vinyl cover: 8150A

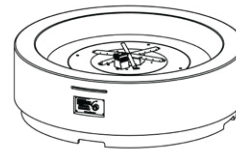

Louvre Round Fire Pit*	
Model #:	686-xx-11-M6xC
Dimensions:	48" dia x 15¼"h
Weight (lbs):	220
Price:	\$4,110

w/ FyreStarter Ignition System †	
Model #:	686-xx-11-H6xC
Price:	\$6,582

-Optional vinyl cover: 8143A

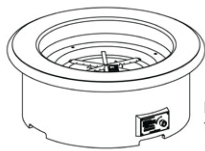

Recessed for field cladding

Contractor's Model Fire Pit*	
Model #:	685-xx-11-M6xC
Dimensions:	39" dia x 14½"h
Weight (lbs):	190
Price:	\$2,951

w/ FyreStarter Ignition System †	
Model #:	685-xx-11-H6xC
Price:	\$5,423

-Optional vinyl cover: 8140A

FIRE PIT VALVES

VALVE	DESCRIPTION	GAS	BTU's
M6	16" Star Burner	NG	65k
	16" Star Burner	LP	65k
H6	16" Star Burner w/ FyreStarter	NG	100k
	16" Star Burner w/ FyreStarter	LP	100k
M7	36" Linear Burner	NG	65k
	36" Linear Burner	LP	65k
H7	36" Linear Burner w/ FyreStarter	NG	75k
	36" Linear Burner w/ FyreStarter	LP	75k
M8	48" Linear Burner	NG	65k
	48" Linear Burner	LP	65k
H8	48" Linear Burner w/ FyreStarter	NG	100k
	48" Linear Burner w/ FyreStarter	LP	100k

M-series valves now include a spark igniter.

ORDERING NOTES:

1. "-xx" = Insert color from STEP 2 on page 11.
2. * Cannot accommodate an LP tank inside the unit; selecting Propane may require Tank/End Table and Hose (see page 14).
3. † FyreStarter = Bluetooth remote control, requires 120 Volt AC Power. Includes **A** and **C** USB ports.
4. Fire Media sold separately! See pages 12 & 13 for available Fyre Glass, gas logs & lava fyre options.

Fire Urns

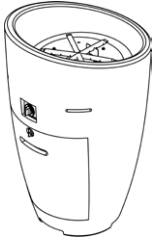

Eclipse Fire Urn	
Model #:	520-xx-11-M2xC
Dimensions:	23" dia x 37½"h
Weight (lbs):	170
Price:	\$2,585

-Optional vinyl cover: 8141A

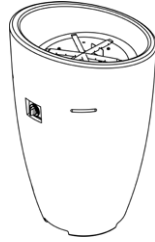

Eclipse Fire Urn* (without access door)	
Model #:	520-xx-10-M2NC
Dimensions:	23" dia x 37½"h
Weight (lbs):	170
Price:	\$2,450

-Natural Gas only
-Optional vinyl cover: 8141A



Wave Fire Urn	
Model #:	530-xx-11-M2xC
Dimensions:	20" dia x 37½"h
Weight (lbs):	150
Price:	\$2,585

-Optional vinyl cover: 8141A

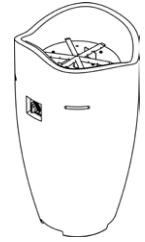

Wave Fire Urn* (without access door)	
Model #:	530-xx-10-M2NC
Dimensions:	20" dia x 37½"h
Weight (lbs):	150
Price:	\$2,450

-Natural Gas only
-Optional vinyl cover: 8141A

Lanterns

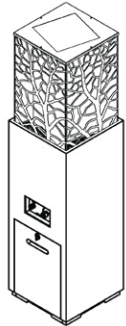

Magnolia Lantern#	
Model #:	716-xx-11-M1xC
Dimensions:	16"w x 16"d x 66"h
Weight (lbs):	160
Price:	\$2,843

w/ FyreStarter Ignition System †	
Model #:	716-xx-11-H1xC
Price:	\$5,315

-Optional vinyl cover: 8134A

LANTERN VALVES

VALVE	DESCRIPTION	GAS	BTU's
M1	Lantern Burner	NG	25k
	Lantern Burner	LP	23k
H1	Lantern Burner w/ FyreStarter	NG	28k
	Lantern Burner w/ FyreStarter	LP	27k

M-series valves now include a spark igniter.

† Magnolia Lanterns may not use Reflective Fyre Glass or Diamond Nuggets.
See Page 12 for available Glass Media.

FIRE URN VALVES

VALVE	DESCRIPTION	GAS	BTU's
M2	12" Star Burner	NG	60k
	12" Star Burner	LP	60k

M-series valves now include a spark igniter.

STEP 2: Choose Color Option(s)

FINISH COLORS	MODEL #
White Aspen	xxx-WA-xx-xxxC
Café Blanco	xxx-CB-xx-xxxC
Black Lava	xxx-BA-xx-xxxC
Smoke	xxx-SM-xx-xxxC

ANTIQUE FINISHES	MODEL #
Travertine	xxx-TR-xx-xxxC
Dark Basalt	xxx-DB-xx-xxxC
Light Basalt	xxx-LB-xx-xxxC

RECLAIMED WOOD FINISHES	MODEL #
French Barrel Oak	xxx-FO-FO-xxxC
Silver Pine	xxx-SP-SP-xxxC

"Reclaimed Wood" finish options are only available for the Bordeaux Square Fire Bowl (430 model).

- American Fyre Designs™ products are individually handcrafted, the finishes listed are subject to slight texture and color variation.
- American Fyre Designs™ reserves the right to change or discontinue finishes without prior notice. Samples available upon request.

STEP 3: Choose Gas Option

GAS OPTIONS	MODEL #
Natural Gas	xxx-xx-xx-xxNC
Propane Gas	xxx-xx-xx-xxPC

Note: All Firetables, Fire Bowls, & Fire Pits are crated for shipment.

Fyre Glass



AVAILABLE COLORS	10 lb. Package \$103	40 lb. Bucket \$414
Azuria	GL-10-F	GL-40-F
Black	GL-10-B	GL-40-B
Bronze	GL-10-Z	GL-40-Z
Caribbean Blue	GL-10-N	GL-40-N
Clear	GL-10-C	GL-40-C
Emerald	GL-10-E	GL-40-E
Star Fyre	GL-10-W	GL-40-W

Reflective Fyre Glass



AVAILABLE COLORS	10 lb. Package \$114	40 lb. Bucket \$451
Azuria Reflective	GL-10-FR	GL-40-FR
Black Reflective	GL-10-BR	GL-40-BR
Bronze Reflective	GL-10-ZR	GL-40-ZR
Caribbean Blue Reflective	GL-10-NR	GL-40-NR
Copper Reflective	GL-10-QR	GL-40-QR
Emerald Reflective	GL-10-ER	GL-40-ER
Gold Reflective	GL-10-HR	GL-40-HR
Champagne Reflective	GL-10-CR	GL-40-CR

Fyre Gems

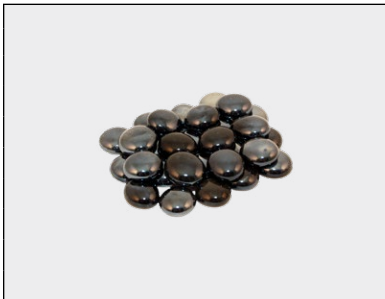

AVAILABLE COLORS	10 lb. Package \$87	40 lb. Bucket \$343
Black Pearl	GLG-10-J	GLG-40-J
Blue Topaz	GLG-10-T	GLG-40-T
Champagne	GLG-10-D	GLG-40-D
Deep Amber	GLG-10-A	GLG-40-A
Emerald	GLG-10-E	GLG-40-E
Glacier	GLG-10-C	GLG-40-C
Sapphire	GLG-10-S	GLG-40-S
Ruby	GLG-10-RY	GLG-40-RY

Diamond Nuggets



AVAILABLE COLORS	10 lb. Package \$99	40 lb. Bucket \$398
Clear	GLD-10-C	GLD-40-C
Steel Blue	GLD-10-SB	GLD-40-SB
Rosé	GLD-10-R	GLD-40-R
Emerald	GLD-10-E	GLD-40-E
Pacific Blue	GLD-10-PB	GLD-40-PB
Deep Black	GLD-10-DB	GLD-40-DB

Recommended Amount of Glass Media to Purchase (in addition to the included base media) *

ITEM DESCRIPTION	AMT.
Magnolia Lantern (716) (NOTE: Magnolia Lanterns may not use Reflective Glass or Diamond Nuggets)	6 lbs
Cosmo Rect. Firetable (635), Cosmo Square Firetable (640), Voro (725), Voro Cube (726), Contempo Rect. Firetable (783), Contempo Square Firetable (784), Contempo LP Select (785)	10 lbs
Legend LP Select (585)	15 lbs
Cosmo Round Firetable (645), Fiesta Firetable (770), Fiesta Dining Firetable (775), Contempo Round Firetable (782), 24" Marseille Fire Bowl (755), Wave Urn (530), 32" Chat Fire Bowl (735), 36" Chat Fire Bowl (736), 48" Chat Fire Bowl (738)	20 lbs
Iron Saddle Firetable (580), Legend Firetable (581), Legend Long LP Select (587)	25 lbs
Contractor's Model Fire Pit (685) (low setting), Bordeaux Petite Square Fire Bowl (431), 32" Fire Bowl (733), Manhattan Fireplace (082), Eclipse Urn (520)	30 lbs
Milan Tall Linear Firetable (215), Milan Low Linear Firetable (216), Milan Tall Linear Fireplace (211-TA), Milan Low Linear Fireplace (211-L0)	35 lbs
Cosmo Sq. Dining Firetable (642), Bordeaux Square Fire Bowl (430), 32" Marseille Fire Bowl (753), Calais Oval Firetable (759), Iron Saddle Long Firetable (588), Legend Long Firetable (589), Contempo Long LP Select (788)	40 lbs
Louvre Rectangle Fire Pit (689), Bordeaux Rectangle Fire Bowl (435), 36" Fire Bowl (732)	50 lbs
Louvre Long Rectangle Fire Pit (688), Contractor's Model Fire Pit (685) (high setting)	60 lbs
Louvre Round Fire Pit (686), 48" Fire Bowl (731)	70 lbs
40" Marseille Fire Bowl (752)	80 lbs
48" Marseille Fire Bowl (751)	110 lbs

*All AFD firetables, fire pits, and fire bowls along with Manhattan fireplace **include a 10# or 5# bag of lava granules (LF-10 or LF-5)** to serve as base media. Not included with Magnolia Lantern, Eclipse, or Wave fire urns.

Fyre Spheres

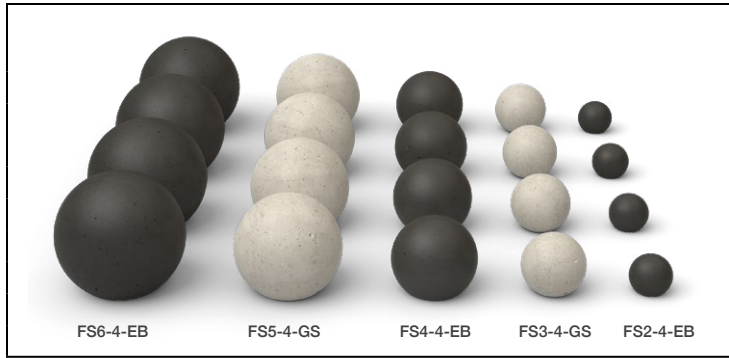

DESCRIPTION	COLOR	MODEL #	PRICE
2" Fyre Spheres (4 in a box)	Epic Black	FS2-4-EB	\$40
	Graystone	FS2-4-GS	37
3" Fyre Spheres (4 in a box)	Epic Black	FS3-4-EB	50
	Graystone	FS3-4-GS	46
4" Fyre Spheres (4 in a box)	Epic Black	FS4-4-EB	58
	Graystone	FS4-4-GS	53
5" Fyre Spheres (4 in a box)	Epic Black	FS5-4-EB	87
	Graystone	FS5-4-GS	79
6" Fyre Spheres (4 in a box)	Epic Black	FS6-4-EB	135
	Graystone	FS6-4-GS	122

Gas Log Sets, Stones & Lava



GAS LOGS, STONES & LAVA	MODEL #	PRICE
Back Country Oak †	BCO-27	\$646
Desert Sage †	DS-27	646
Prairie Oak †	PRO-27	609
Campfyre Logs, Wood Chips †	OCL-34	397
Beachwood Logs, Stones †	OCBW-34	430
Desert Sage Branches	BDS-2	125
Charred Branches	BDC-4	124
36-Pc. Wood Chunks	WCD-36	317
10-Pc. River Rock Fyre Stones	STN-10	142
20-Pc. River Rock Fyre Stones	STN-20	332
140-Pc. Creekstones, Greige	CSTN-20-G	355
140-Pc. Creekstones, Cloud	CSTN-20-C	355
140-Pc. Creekstones, Mixed (Greige & Cloud)	CSTN-20-CG	355
140-Pc. Creekstones, Black	CSTN-20-B	410
Lava Stones (35 lbs)	LVS-35	110
Lava Stones (15 lbs)	LVS-15	68
Lava Fyre Coals (10 lbs)	LFC-10	47
Lava Fyre Granules (10 lbs)	LF-10	40
Lava Fyre Granules (5 lbs)	LF-5	25

†Lava needs to be ordered separately

† Log sets pictured with recommended Lava Granules or Lava Coals. Lava Granules & Lava Coals are not included with log set and must be ordered separately. Additional River Rock and accessories available. See Peterson Real Fyre® Price List# L-A3-02124

Recommended Amount of Lava Media (Granules & Coals) to Purchase (in addition to the included base media) *

ITEM DESCRIPTION	AMT.
Cosmopolitan Rectangle Firetable (635), Cosmopolitan Square Firetable (640), Cosmopolitan Round Firetable (645), Voro Firetable (725), Voro Cube (726), Contempo Round Firetable (782), Contempo Rectangle Firetable (783), Contempo Square Firetable (784), Contempo LP Select (785), 24" Marseille Fire Bowl (755), Iron Saddle Firetable (580), Legend Firetable (581), Iron Saddle Firetable (580), Legend LP Select (585), 32" Chat Fire Bowl (735), 36" Chat Fire Bowl (736), 48" Chat Fire Bowl (738)	10 lbs
Fiesta Firetable (770), Fiesta Dining Firetable (775), Wave Urn (530), Bordeaux Petite Square Fire Bowl (431), Manhattan Fireplace (082), Legend Long LP Select (587)	15 lbs
Eclipse Urn (520), Contractor's Model Fire Pit (685) (low setting), Bordeaux Square Fire Bowl (430), 32" Marseille Fire Bowl (753), Milan Tall Linear Firetable (215), Milan Low Linear Firetable (216), Calais Oval Firetable (759), Milan Tall Linear Fireplace (211-TA), Milan Low Linear Fireplace (211-L0)	20 lbs
Cosmopolitan Square Dining Firetable (642), 32" Fire Bowl (733), Iron Saddle Long Firetable (588), Legend Long Firetable (589), Contempo LP Select Long (788)	25 lbs
Louvre Rectangle Fire Pit (689), Contractor's Model Fire Pit (685) (high setting), Bordeaux Rectangle Fire Bowl (435), 36" Fire Bowl (732)	30 lbs
48" Fire Bowl (731)	35 lbs
Louvre Round Fire Pit (686), Louvre Long Rectangle Fire Pit (688), 40" Marseille Fire Bowl (752)	40 lbs
48" Marseille Fire Bowl (751)	50 lbs

*All AFD firetables, fire pits, and fire bowls along with Manhattan fireplace include a 10# or 5# bag of lava granules (LF-10 or LF-5) to serve as base media. Not included with Magnolia Lantern, Eclipse, or Wave fire urns.

Lava Media may not be used with Lanterns.

Vinyl Protective Covers

PRODUCT DESCRIPTION - (Model Prefix)	MODEL #	PRICE
FIREPLACES		
Milan Low Linear - (211-L0)	8145A	\$185
Milan Tall Linear - (211-TA)	8145A	\$185
FIRETABLES		
Fiesta - (770)	8131A	\$102
Iron Saddle - (580)	8152A	\$128
Iron Saddle Long - (588)	8153A	\$196
Legend - (581 & 585)	8152A	\$128
Legend Long - (589 & 585)	8153A	\$196
Contempo Rectangle - (783)	8139A	\$125
Contempo Square - (784)	8146A	\$112
Contempo Round - (782)	8143A	\$111
Contempo LP Select - (785)	8139A	\$125
Contempo LP Select Long - (788)	8155A	\$202
Cosmopolitan Rectangle - (635)	8138A	\$143
Cosmopolitan Square - (640)	8132A	\$81
Cosmopolitan Round - (645)	8135A	\$144
Calais Oval - (759)	8151A	\$126
Voro - (725)	8132A	\$81
Milan Tall Linear - (215)	8144A	\$176
Cosmopolitan Square Dining - (642)	8137A	\$210
Fiesta Dining - (775)	8131A	\$102
Long Fire Pits - (588), (589)	8153A	\$196
FIRE PITS		
48" Louvre - (686)	8143A	\$111
Louvre Long Rectangle - (688)	8149A	\$151
Louvre Rectangle - (689)	8150A	\$131
Fire Pits - (685)	8140A	\$111
FIRE BOWLS		
48" Fire Bowl - (731)	8135A	\$144
Fire Bowls - (732, 752)	8140A	\$111
Fire Bowls - (733, 753)	8142A	\$88
48" Marseille - (751)	8143A	\$111
Bordeaux Rectangle - (435)	8148A	\$126
Bordeaux Square - (430, 431)	8132A	\$81
FIRE URNS & LANTERNS		
Eclipse - (520)	8141A	\$82
Wave - (530)	8141A	\$82
Magnolia - (716)	8134A	\$111
Propane Tank Nylon Cover	5110-13-20	\$62

GFRC Covers

RECLAIMED WOOD

PRODUCT DESCRIPTION - (Model Prefix)	WT. (lbs)	MODEL #	PRICE	MODEL #	PRICE
FIRETABLES					
Fiesta - (770)	16	8100-XX	\$178	N/A	
Iron Saddle - (580)	39	8115-XX	\$383		
Legend - (581)	39	8115-XX	\$383		
Contempo Rectangle - (783)	25	8110-XX	\$210	8110-FO (-SP)	\$287
Contempo Square - (784)	18	8120-XX	\$178	8120-FO (-SP)	\$236
Contempo Round - (782)	16	8100-XX	\$178	8100-FO (-SP)	\$236
Contempo LP Select - (785)	25	8110-XX	\$210	8110-FO (-SP)	\$287
Cosmopolitan Rectangle - (635)	25	8110-XX	\$210	8110-FO (-SP)	\$287
Cosmopolitan Square - (640)	18	8120-XX	\$178	8120-FO (-SP)	\$236
Cosmopolitan Round - (645)	16	8100-XX	\$178	8100-FO (-SP)	\$236
Voro - (725, 726)	18	8120-XX	\$178	N/A	
Cosmo Square Dining - (642)	45	8123-XX	\$265	8123-FO (-SP)	\$315
Fiesta Dining - (775)	16	8100-XX	\$178	N/A	

"xx" = Insert color from Pg. 13 colors

Stainless Steel Covers

PRODUCT DESCRIPTION - (Model Prefix)	WT. (lbs)	MODEL #	PRICE
FIRETABLES			
Iron Saddle Long - (588)	24	8116-SS	\$292
Legend Long - (589)	24	8116-SS	\$292
Contempo LP Select Long - (788)	24	8116-SS	\$292



Tank/End Tables & Extension Hose

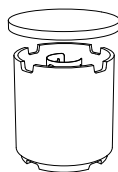
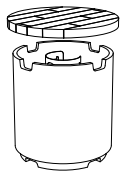

Reclaimed Wood Contempo Tank/End Table *
FO Model #: 8510-BA-FO
SP Model #: 8510-BA-SP
Dimensions: 20¾" dia x 19¼"h
Price: \$478

Contempo Tank/End Table *
Model #: 8510-xx
Dimensions: 20¾" dia x 19¼"h
Price: \$400

10 ft. LP Extension Hose w/ Elbow Fitting
Model #: 5110-26
Dimensions: 10 ft. long
Price: \$107

* Propane tank and hose not included.

"-xx" = insert color from Pg. 13 colors.

Tempered Glass Wind Guards

DESCRIPTION	SIZE	COMPATIBLE MODELS	MODEL #	PRICE
Square Wind Guard	19¼" w x 19¼" d x 6¾" h	640, 725, 784	8202-WG	\$392
Rectangular Wind Guard	35" w x 14½" d x 6¾" h	635, 783, 785	8204-WG	459
Round Wind Guard	26" dia x 6¾" h	All Round Firetables	8208-WG	501
Large Square Wind Guard	28" w x 28" d x 6¾" h	642	8210-WG	567
Milan Wind Guard	51½" w x 14½" d x 6¾" h	215, 216, 587	8212-WG	639
Large Rect. Wind Guard	43" w x 19¼" d x 6¾" h	580, 581	8211-WG	602
Large Rect. Wind Guard	43" w x 14½" d x 6¾" h	585	8213-WG	570
Large Rect. Wind Guard	51½" w x 19¼" d x 6¾" h	588, 589, 788	8218-WG	669

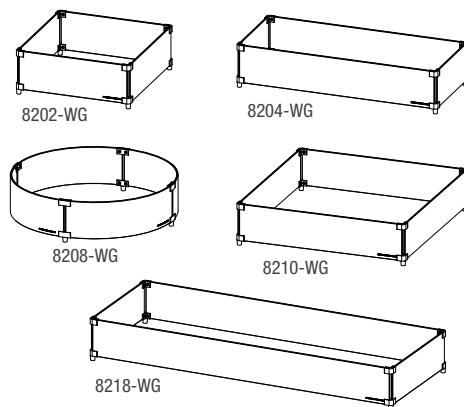

Gas Conversion Kits

FIRESTARTER VALVE		MANUAL FLAME SENSING CONTROL VALVE		AWEIS VALVE (Pre 2022)		PUSH-TO-TURN (Pre 2021)		KEY VALVE (Pre 2021)		
Model Prefix	LP to NG	NG to LP	LP to NG	NG to LP	LP to NG	NG to LP	LP to NG	NG to LP	LP to NG	NG to LP
FIRETABLES										
725, 726	N/A		MCK-01-NAT \$68	MCK-01-LP \$75	N/A		CK-11-NAT \$64	CK-13-LP \$64	CK-20-NAT \$64	CK-22-LP \$64
770, 775	N/A		MCK-01-NAT \$68	MCK-10-LP \$75	N/A		CK-11-NAT \$64	CK-13-LP \$64	CK-20-NAT \$64	CK-22-LP \$64
783, 784, 782	HCK-02-NAT \$176	HCK-02-LP \$176	MCK-02-NAT \$34	MCK-02-LP \$34	CK-81-NAT \$25	CK-85-LP \$33	CK-12-NAT \$16	CK-15-LP \$25	CK-21-NAT \$16	CK-24-LP \$25
785	N/A		MCK-02-NAT \$34	MCK-02-LP \$34	N/A		N/A		N/A	
759	HCK-02-NAT \$176	HCK-02-LP \$176	MCK-02-NAT \$34	MCK-02-LP \$34	N/A		CK-12-NAT \$16	CK-15-LP \$25	CK-21-NAT \$16	CK-24-LP \$25
640, 645	HCK-01-NAT \$223	HCK-01-LP \$216	MCK-01-NAT \$68	MCK-01-LP \$75	CK-79-NAT \$84	CK-83-LP \$68	CK-11-NAT \$64	CK-13-LP \$64	CK-20-NAT \$64	CK-22-LP \$64
635	HCK-01-NAT \$223	HCK-09-LP \$205	MCK-01-NAT \$68	MCK-09-LP \$68	CK-79-NAT \$84	CK-82-LP \$68	CK-11-NAT \$64	CK-14-LP \$64	CK-20-NAT \$64	CK-23-LP \$64
642	HCK-08-NAT \$216	HCK-08-LP \$201	MCK-03-NAT \$68	MCK-03-LP \$75	CK-80-NAT \$84	CK-84-LP \$107	CK-51-NAT \$64	CK-53-LP \$64	CK-55-NAT \$64	CK-57-LP \$64
215, 216	HCK-07-NAT \$201	HCK-07-LP \$201	MCK-06-NAT \$55	MCK-06-LP \$55	CK-76-NAT \$33	CK-78-LP \$49	N/A		N/A	
580, 581	HCK-06-NAT \$201	HCK-06-LP \$205	MCK-06-NAT \$55	MCK-06-LP \$55	N/A		N/A		N/A	
FIRE PITS										
685, 686	HCK-04-NAT \$176	HCK-04-LP \$176	MCK-04-NAT \$34	MCK-04-LP \$34	CK-72-NAT \$25	CK-74-LP \$33	CK-52-NAT \$16	CK-54-LP \$25	CK-56-NAT \$16	CK-58-LP \$25
689	HCK-06-NAT \$201	HCK-06-LP \$205	MCK-06-NAT \$55	MCK-06-LP \$55	CK-95-NAT \$64	CK-96-LP \$64	CK-87-NAT \$16	CK-88-LP \$16	CK-89-NAT \$25	CK-90-LP \$16
688	HCK-07-NAT \$201	HCK-07-LP \$201	MCK-06-NAT \$55	MCK-06-LP \$55	CK-76-NAT \$33	CK-78-LP \$49	CK-91-NAT \$84	CK-92-LP \$49	CK-93-NAT \$64	CK-94-LP \$49
FIRE BOWLS										
753, 431, 755	N/A		MCK-04-NAT \$34	MCK-04-LP \$34	N/A		CK-52-NAT \$16	CK-54-LP \$25	CK-56-NAT \$16	CK-58-LP \$25
732, 733, 751, 752	HCK-04-NAT \$176	HCK-04-LP \$176	MCK-04-NAT \$34	MCK-04-LP \$34	CK-72-NAT \$25	CK-74-LP \$33	CK-52-NAT \$16	CK-54-LP \$25	CK-56-NAT \$16	CK-58-LP \$25
430	HCK-04-NAT \$176	HCK-04-LP \$176	MCK-04-NAT \$34	MCK-04-LP \$34	N/A		CK-52-NAT \$16	CK-54-LP \$25	CK-56-NAT \$16	CK-58-LP \$25
435, 735, 736	HCK-02-NAT \$176	HCK-02-LP \$176	MCK-02-NAT \$34	MCK-02-LP \$34	N/A		CK-12-NAT \$16	CK-15-LP \$25	CK-21-NAT \$16	CK-24-LP \$25
731	HCK-03-NAT \$223	HCK-03-LP \$243	MCK-03-NAT \$68	MCK-03-LP \$75	CK-71-NAT \$84	CK-73-LP \$95	CK-51-NAT \$64	CK-53-LP \$64	CK-55-NAT \$64	CK-57-LP \$64
FIRE URNS & LANTERNS										
520, 530	N/A		MCK-01-NAT \$68	MCK-01-LP \$75	N/A		CK-11-NAT \$64	CK-13-LP \$64	CK-20-NAT \$64	CK-22-LP \$64
716	HCK-05-NAT \$216	HCK-05-LP \$216	MCK-05-NAT \$68	MCK-05-LP \$68	N/A		CK-16-NAT \$64	CK-17-LP \$64	CK-25-NAT \$64	CK-26-LP \$64

American Fyre Designs Burners

BURNER DESCRIPTION	MODEL #	BTU's		PRICE
		N.G.	L.P.	
12" Star Burner * (Without Valve) LP	OCBS-12P	--	50k	\$123
12" Star Burner * (Without Valve) NAT	OCBS-12	60k	--	123
16" Star Burner ** (Without Valve) LP	OCBS-16P	--	60k	144
16" Star Burner ** (Without Valve) NAT	OCBS-16	65k	--	144

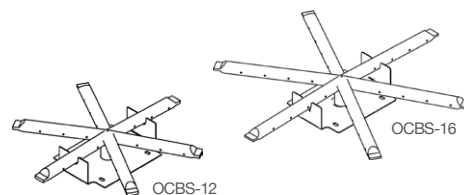

* Also used as replacement for most firetables on pages 6, 7 & 8.

** Also used as replacement for Cosmo. Square Dining (pg. 8), most Fire Bowls (pg. 9), and most Fire Pits (pg. 10).

FIREPLACE PART NUMBER BREAK DOWN & ORDERING GUIDE

882

Fireplace Style
PAGE 2-3

-

35

Hearth Style
PAGE 2

-

N

Recess Option
N = No Recess
H = Hearth Only
A = Hearth & Body

-

CB

Color Choice
PAGE 4

-

RB

Gas Shut Off
PAGE 4

C

Crating

Follow these step-by-step guidelines to configure the right fireplace for you.

Step 1 - Fireplace Style - Select your fireplace style (vented or vent-free).

Step 2 - Hearth Style - The fireplace rests on a hearth base – select the size and style that suits your application.

Step 3 - Recess Option - Some AFD fireplaces may be clad with your own finishing materials like stone or brick. For these units, you may select the “recess” option to accommodate such materials.

Step 4 - Color Choice - Choose your finish which comes in five finish color options.

Step 5 - Gas Shut Off & Line Location - Determine where your gas shut off control and line should be positioned.

Step 6 - Select Media Type and Burner - logs or glass media in natural gas or propane suitable for fireplace chosen (vented or vent-free)

- Optional fireplace accessories shown on page 4 & 5 - consider adding a cover, screen or rain cap.
- Note: All fireplaces are crated for shipment.

FIRETABLES, PITS, BOWLS, & URNS PART NUMBER BREAK DOWN & ORDERING GUIDE

782

Fire Feature Style
PAGE 6-11

-

CB

Color Choice
PAGE 11

-

11

Top Style
11 = GFRC
FO = French Barrel Oak
SP = Silver Pine

-

M2

Valves
H = FyreStarter
M = Manual Flame Sensing Control w/ spark igniter

N

Gas Type
N = Natural
P = Propane

C

Crating

Follow these step-by-step guidelines to configure the right product for you.

Step 1 - Fire Feature Style - Select the AFD fire feature you desire.

Step 2 - Color Choice - Choose your finish which comes in five finish color options and three antique finish options.

Step 3 - Top Style - Choose your top style (available for select firetable models only).

Step 4 - Gas Type - Choose either Natural gas (N) or propane (P).

Step 5 - Select Media Type - Gas logs, stones, lava, or glass media.

- Consider adding a cover - see page 14.
- Note: All firetables, fire pits, fire bowls, and fire urns are crated for shipment.

ALL AMERICAN Fyre DESIGNS™ PRODUCTS ARE MADE TO ORDER AND CANNOT BE CANCELED.

American Fyre Designs™ products are certified to ANSI Z21.97-2017 and CSA 2.41 as outdoor decorative gas appliances.

AFD PRODUCTS ARE FOR OUTDOOR USE ONLY

AMERICAN Fyre DESIGNS™ LIMITED WARRANTY HIGHLIGHTS

THREE (3) YEAR WARRANTY

American Fyre Designs™ exterior (GFRC) Fireplaces, Firetables, Fire Bowls, Fire Urns, and Fire Pits are warranted for three (3) years.

ONE (1) YEAR WARRANTY

American Fyre Designs™ burners, electronic components, and valves are warranted for one (1) year.

This warranty applies to the original purchaser with invoice or proof of purchase and to single family residential use only. For additional information regarding this warranty, or to place a warranty claim contact your authorized AFD dealer

This price list may not be copied, photocopied, reproduced, translated, or published in any electronic or machine-readable form in whole or in part without prior written approval of Robert H. Peterson Co.

RH PETERSON CO.

14724 Proctor Ave • City of Industry, CA 91746 • Website: www.rhpeterson.com • (626) 369-5085 • Fax (626) 369-5979