

DirectVent Pro

| Installation Key | | | |
|------------------|--------------------------------|----|---------------------------------|
| 1 | Vertical Termination Cap | 9 | 90° Elbow |
| 2 | Storm Collar | 10 | Horizontal Termination Cap |
| 3 | Flashing | 11 | Snorkel Termination Cap |
| 4 | Cathedral Ceiling Support Box | 12 | Colinear Kit |
| 5 | Pipe | 13 | 3" Flex |
| 6 | 45° Elbow | 14 | Co-Axial to Co-Linear Connector |
| 7 | Class A Chimney Conversion Kit | 15 | Masonry Chimney Conversion Kit |
| 8 | 4" Flex | 16 | Elbow Strap |

Applications

DirectVent Pro is a unitized, coaxial (concentric) venting system designed for use w/ direct vent gas or propane stoves, heaters, and fireplaces.

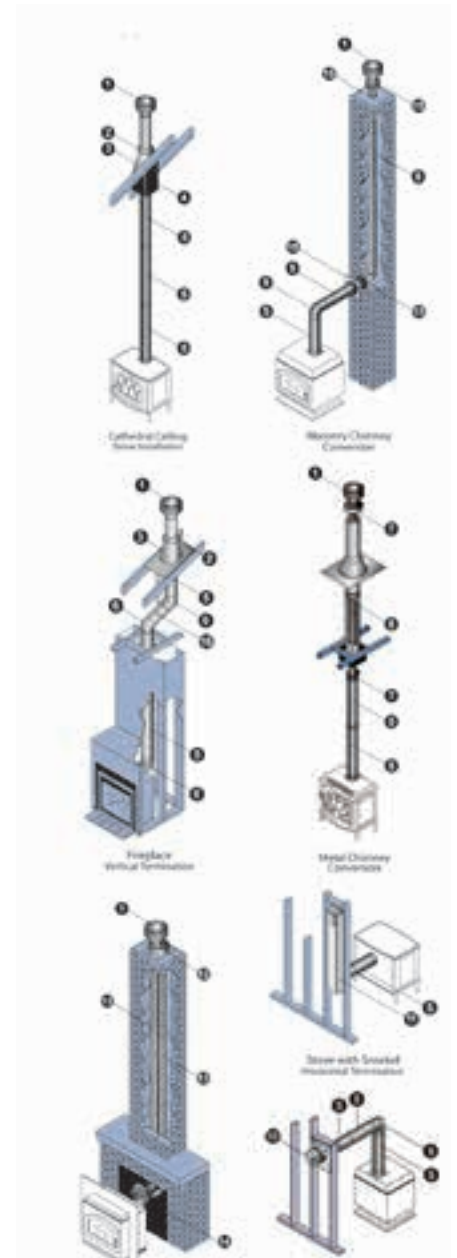
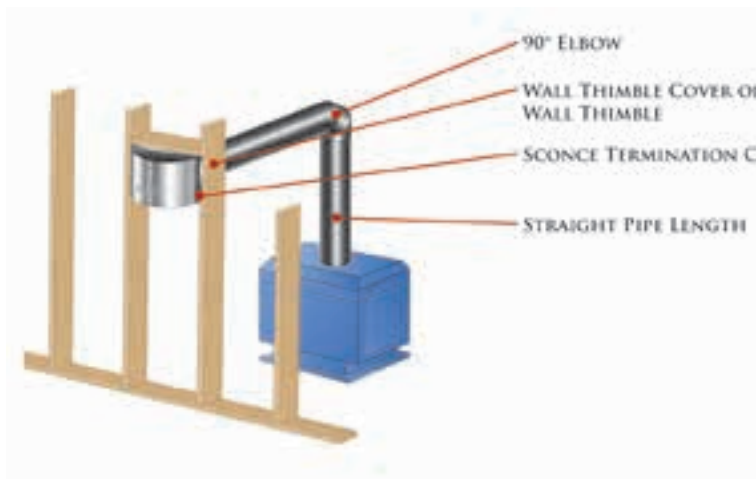

SOME BRANDS ARE ONLY AVAILABLE IN SELECTED AREAS, SEE MAP ON PAGE 4 OR CONTACT YOUR REGIONAL SALES MANGER FOR MORE INFO.

Pricing, model numbers and availability are subject to change without notice. Call for most current information.

❖ – Non Stock Special Order

Goldsboro (Best & Langston) Ph: 888-260-1900 Fax: 919-739-9920

Horizontal Termination Kit A

Kit includes: 90° black elbow, ceiling support/wall thimble cover, 24" black pipe, 8 1/2" black pipe extension. Termination cap not included. For 4" x 6 5/8" direct vent. Choose termination cap to complete installation.

| SIZE | STOCK # | List Price |
|-------------|-----------|------------|
| 4" x 6 5/8" | 46DVA-KHA | \$360.95 |



Horizontal Termination Kit C

Kit includes: 90° black elbow, wall thimble, ceiling support/wall thimble cover, 24" black pipe, 8 1/2" black pipe extension. Termination cap not included. For 4" x 6 5/8" direct vent. Choose termination cap to complete installation.

| SIZE | STOCK # | List Price |
|-------------|-----------|------------|
| 4" x 6 5/8" | 46DVA-KHC | \$426.47 |



Masonry Chimney Conversion Kit

Kit 46DVA-KMC includes: cap adaptor, 18" x 18" flashing, round ceiling support/wall thimble cover, retro connector. For 4" x 6 5/8" direct vent. Termination cap and 4" flex are sold separately.

Kit 46DVA-KCT includes: cap adaptor and an 18" x 18" flashing.

| SIZE | STOCK # | List Price |
|-------------|-----------|------------|
| 4" x 6 5/8" | 46DVA-KMC | \$296.97 |
| 4" x 6 5/8" | 46DVA-KCT | \$114.79 |

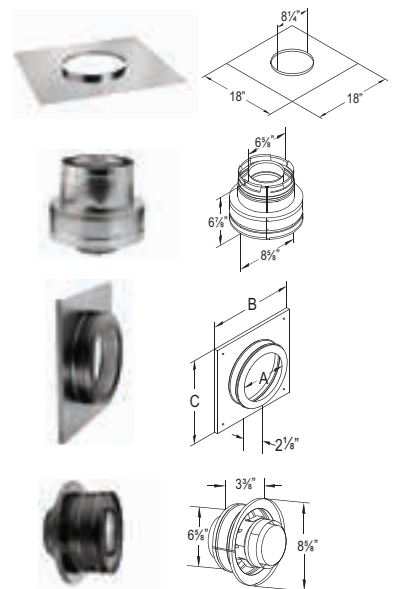

Chimney Conversion Kit

Kits 46DVA-KCA and 46DVA-KCB include: cap adaptor and a retro connector. DirectVent Pro 4" x 6 5/8" termination cap and 4" flex are sold separately.

| SIZE | STOCK # | A | B | C | List Price |
|-------------|-----------|--------|---------|--------|------------|
| 4" x 6 5/8" | 46DVA-KCA | 6 5/8" | 8 5/8" | 6 7/8" | \$246.46 |
| 4" x 6 5/8" | 46DVA-KCB | 6 5/8" | 10 1/2" | 5 7/8" | \$246.46 |
| 4" x 6 5/8" | 46DVA-KCC | 6 5/8" | 13" | 5 7/8" | \$246.46 |

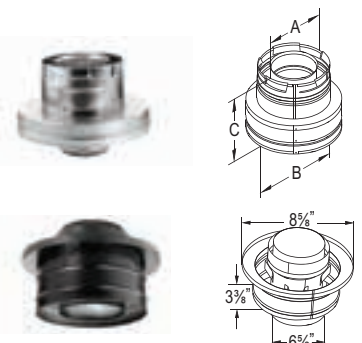

SOME BRANDS ARE ONLY AVAILABLE IN SELECTED AREAS, SEE MAP ON PAGE 4 OR CONTACT YOUR REGIONAL SALES MANGER FOR MORE INFO.

Pricing, model numbers and availability are subject to change without notice. Call for most current information.

Pipe Length

| SIZE | GALVANIZED | List Price | BLACK | List Price | A |
|-------------|------------|------------|-------------|------------|-----|
| 4" x 6 5/8" | 46DVA-06 | \$32.37 | 46DVA-06B | \$57.36 | 6" |
| 4" x 6 5/8" | 46DVA-09 | \$36.93 | 46DVA-09B | \$56.76 | 9" |
| 4" x 6 5/8" | 46DVA-12 | \$42.65 | 46DVA-12B | \$62.90 | 12" |
| 4" x 6 5/8" | 46DVA-18 | \$50.67 | 46DVA-18B | \$70.93 | 18" |
| 4" x 6 5/8" | 46DVA-24 | \$58.24 | 46DVA-24B | \$81.52 | 24" |
| 4" x 6 5/8" | 46DVA-36 | \$71.12 | 46DVA-36B | \$99.55 | 36" |
| 4" x 6 5/8" | 46DVA-48 | \$85.00 | 46DVA-48B | \$119.00 | 48" |
| 4" x 6 5/8" | 46DVA-60 | \$113.26 | 46DVA-60B | \$158.58 | 60" |
| 5" x 8" | 58DVA-06 | \$38.08 | 58DVA-06B ❖ | \$67.49 | 6" |
| 5" x 8" | 58DVA-09 | \$43.45 | 58DVA-09B ❖ | \$103.37 | 9" |
| 5" x 8" | 58DVA-12 | \$50.18 | 58DVA-12B ❖ | \$137.83 | 12" |
| 5" x 8" | 58DVA-18 | \$59.61 | 58DVA-18B ❖ | \$83.44 | 18" |
| 5" x 8" | 58DVA-24 | \$68.50 | 58DVA-24B | \$95.61 | 24" |
| 5" x 8" | 58DVA-36 | \$83.66 | 58DVA-36B | \$117.13 | 36" |
| 5" x 8" | 58DVA-48 | \$100.00 | 58DVA-48B | \$134.62 | 48" |
| 5" x 8" | 58DVA-60 | \$133.25 | 58DVA-60B | \$186.55 | 60" |

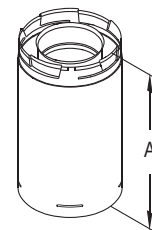

Pipe Extension

| SIZE | GALVANIZED | List Price | BLACK | List Price | A | EXTENSION |
|-------------|------------|------------|--------------|------------|--------|--------------|
| 4" x 6 5/8" | 46DVA-08A | \$31.70 | 46DVA-08AB | \$48.68 | 8 1/2" | 3" – 7" |
| 4" x 6 5/8" | 46DVA-16A | \$37.60 | 46DVA-16AB | \$55.44 | 16" | 3" – 14 1/2" |
| 5" x 8" | 58DVA-08A | \$37.33 | 58DVA-08AB ❖ | \$57.33 | 8 1/2" | 3" – 7" |
| 5" x 8" | 58DVA-16A | \$46.99 | 58DVA-16AB | \$69.30 | 16" | 3" – 14 1/2" |

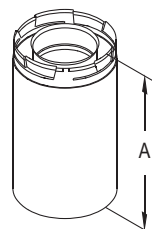

NOTE: 8 1/2" PIPE ADDS 3"-7" OF LENGTH, 16" PIPE ADDS 3-14 1/2" OF LENGTH, WHEN USED WITH RIGID SECTIONS OF PIPE

SOME BRANDS ARE ONLY AVAILABLE IN SELECTED AREAS, SEE MAP ON PAGE 4 OR CONTACT YOUR REGIONAL SALES MANGER FOR MORE INFO.

Pricing, model numbers and availability are subject to change without notice. Call for most current information.

❖ – Non Stock Special Order

Goldsboro (Best & Langston) Ph: 888-260-1900 Fax: 919-739-9920

Adjustable Pipe

Use to add length to a straight length of DirectVent Pro.

| SIZE | GALVANIZED | List Price | BLACK | List Price | A | INSTALLED |
|-------------|------------|------------|---------------|------------|-----------|-------------------|
| 4" x 6 5/8" | 46DVA-17TA | \$58.09 | 46DVA-17TAB | \$107.37 | 11" – 17" | 9 1/2" – 15 1/2" |
| 4" x 6 5/8" | 46DVA-24TA | \$66.79 | 46DVA-24TAB | \$115.04 | 17" – 24" | 15 1/2" – 22 1/2" |
| 5" x 8" | 58DVA-17TA | \$71.13 | 58DVA-17TAB ❖ | \$344.57 | 11" – 17" | 9 1/2" – 15 1/2" |
| 5" x 8" | 58DVA-24TA | \$74.77 | -- | -- | 17" – 24" | 15 1/2" – 22 1/2" |



30° Elbow

Use to offset obstructions as needed.

| SIZE | GALVANIZED | List Price | A | B |
|-------------|------------|------------|--------|--------|
| 4" x 6 5/8" | 46DVA-E30 | \$61.91 | 5 1/4" | 4 7/8" |
| 5" x 8" | 58DVA-E30 | \$119.22 | 6 1/8" | 5 1/2" |

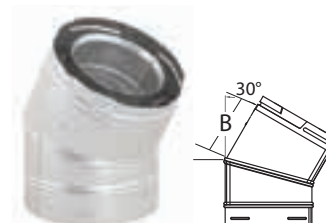

45° Elbow

| SIZE | GALVANIZED | List Price | BLACK | List Price | A | B |
|-------------|------------|------------|------------|------------|--------|--------|
| 4" x 6 5/8" | 46DVA-E45 | \$57.52 | 46DVA-E45B | \$75.26 | 5 3/4" | 5 1/8" |
| 5" x 8" | 58DVA-E45 | \$70.20 | 58DVA-E45B | \$103.54 | 6 5/8" | 6" |



90° Elbow

| SIZE | GALVANIZED | List Price | BLACK | List Price | A | B |
|-------------|------------|------------|------------|------------|--------|--------|
| 4" x 6 5/8" | 46DVA-E90 | \$67.29 | 46DVA-E90B | \$87.91 | 6 1/2" | 6 1/2" |
| 5" x 8" | 58DVA-E90 | \$81.87 | 58DVA-E90B | \$120.76 | 7 3/8" | 7 3/8" |



SOME BRANDS ARE ONLY AVAILABLE IN SELECTED AREAS, SEE MAP ON PAGE 4 OR CONTACT YOUR REGIONAL SALES MANGER FOR MORE INFO.

Pricing, model numbers and availability are subject to change without notice. Call for most current information.

Elbow Strap

Use for supporting vent pipe between offsets.

| SIZE | STOCK # | A | List Price |
|-------------|----------|--------|------------|
| 4" x 6 5/8" | 46DVA-ES | 6 5/8" | \$18.46 |
| 5" x 8" | 58DVA-ES | 8" | \$23.39 |

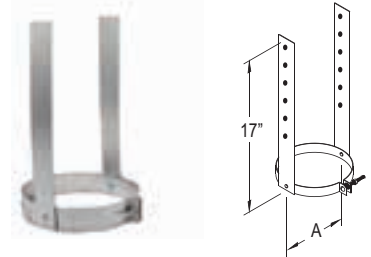

Ceiling Support/Wall Thimble Cover

Use as a decorative cover for horizontal (through-wall) installations or for flat ceiling installations.

| SIZE | STOCK # | A | B | C | List Price |
|-------------|----------|--------|-----|-----|------------|
| 4" x 6 5/8" | 46DVA-DC | 6 7/8" | 13" | 13" | \$74.20 |
| 5" x 8" | 58DVA-DC | 8 1/4" | 13" | 13" | \$85.28 |

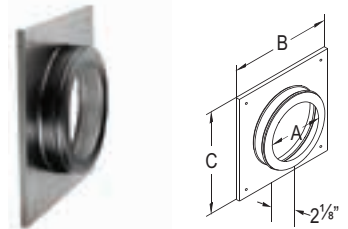

Cathedral Ceiling Support Box

Use to pass through ceiling and support pipe. May be used on vaulted or flat ceilings.

| SIZE | STOCK # | A | B | List Price |
|-------------|------------|--------|---------|------------|
| 4" x 6 5/8" | 46DVA-CS | 6 7/8" | 10 5/8" | \$115.40 |
| 5" x 8" | 58DVA-CS ❖ | 8 1/4" | 10 5/8" | \$144.25 |

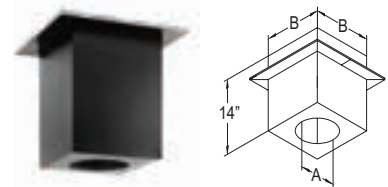

Wall Thimble

Use w/ square horizontal cap only. Provides a complete wall-pass-through firestop.

| SIZE | STOCK # | A | B | C | List Price |
|-------------|----------|--------|-----|-----|------------|
| 4" x 6 5/8" | 46DVA-WT | 6 3/4" | 11" | 11" | \$58.24 |
| 5" x 8" | 58DVA-WT | 8 1/4" | 11" | 11" | \$79.07 |

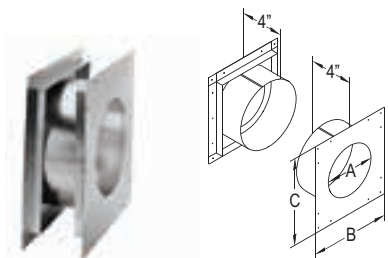

Wall Thimble – Small

Provides a complete wall-pass-through and firestop. Use w/ round horizontal cap, sconce cap and H2 horizontal cap only.

| SIZE | STOCK # | A | B | C | List Price |
|-------------|-----------|--------|----|----|------------|
| 4" x 6 5/8" | 46DVA-WTS | 6 3/4" | 9" | 9" | \$53.09 |
| 5" x 8" | 58DVA-WTS | 8 1/4" | 9" | 9" | \$73.78 |

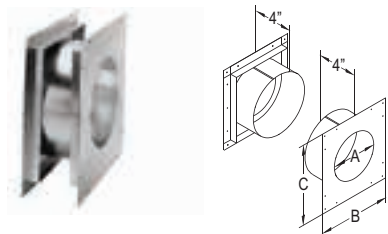

Wall Thimble – Universal

Provides a complete wall-pass-through and interior firestop. Use w/ smaller square and sconce cap.

| SIZE | STOCK # | A | B | List Price |
|-------------|-----------|--------|-----|------------|
| 4" x 6 5/8" | 46DVA-WTU | 6 3/4" | 11" | \$46.02 |
| 5" x 8" | 58DVA-WTU | 8 1/8" | 11" | \$54.73 |

SOME BRANDS ARE ONLY AVAILABLE IN SELECTED AREAS, SEE MAP ON PAGE 4 OR CONTACT YOUR REGIONAL SALES MANGER FOR MORE INFO.

Pricing, model numbers and availability are subject to change without notice. Call for most current information.

❖ – Non Stock Special Order

Goldsboro (Best & Langston) Ph: 888-260-1900 Fax: 919-739-9920

Wall Firestop

For horizontal (through-wall) installations.

| SIZE | STOCK # | A | B | C | List Price |
|-------------|-----------|--------|-----|-----|------------|
| 4" x 6 5/8" | 46DVA-WFS | 6 3/4" | 12" | 10" | \$60.63 |
| 5" x 8" | 58DVA-WFS | 8 1/4" | 12" | 10" | \$74.52 |

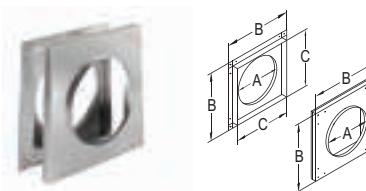

Vinyl Siding Standoff

Use as a heat shield w/ vinyl siding or other temperature sensitive materials, to help prevent warping and or melting of the material. Use only on horizontal terminators.

| SIZE | STOCK # | A | B | C | List Price |
|-------------|-----------|--------|---------|---------|------------|
| 4" x 6 5/8" | 46DVA-VSS | 6 3/4" | 17 1/2" | 13 1/2" | \$76.94 |
| 5" x 8" | 58DVA-VSS | 8 1/4" | 19 7/8" | 15 3/4" | \$119.31 |

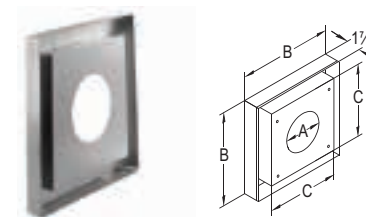

Vinyl Siding Standoff Kit

| SIZE | STOCK # | A | B | C | List Price |
|-------------|-----------|---------|---------|----|------------|
| 4" x 6 5/8" | 46DVA-VSK | 15 1/4" | 13 1/4" | 3" | \$57.16 |
| 5" x 8" | 58DVA-VSK | 15 1/4" | 13 1/4" | 3" | \$63.39 |

Vinyl Siding Standoff Kit - Small

Use w/ sconce cap, round horizontal cap and h2 horizontal cap only.

| SIZE | STOCK # | A | B | C | List Price |
|-------------|------------|---------|---------|----|------------|
| 4" x 6 5/8" | 46DVA-VSKS | 12 7/8" | 10 7/8" | 3" | \$50.25 |



Vinyl Siding Standoff Box

| SIZE | STOCK # | List Price |
|--------------------|---------|------------|
| 4" x 6 5/8" & 5/8" | DVA-BVS | \$57.28 |

Ceiling Firestop

Required for multi-story vertical installations at the second floor and any subsequent floors.

| SIZE | STOCK # | A | B | C | List Price |
|-------------|----------|--------|---------|---------|------------|
| 4" x 6 5/8" | 46DVA-FS | 6 3/4" | 11" | 9" | \$14.03 |
| 5" x 8" | 58DVA-FS | 8 1/4" | 12 1/2" | 10 1/2" | \$17.54 |

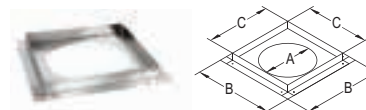

Attic Insulation Shield

Required for installations that pass through an attic to prevent insulation and debris from accumulating near the vent.

| SIZE | STOCK # | A | B | C | List Price |
|-------------|----------|---------|-----------|-----|------------|
| 4" x 6 5/8" | 46DVA-IS | 8 3/4" | 8 15/16" | 11" | \$102.39 |
| 5" x 8" | 58DVA-IS | 10 3/4" | 10 15/16" | 13" | \$127.97 |

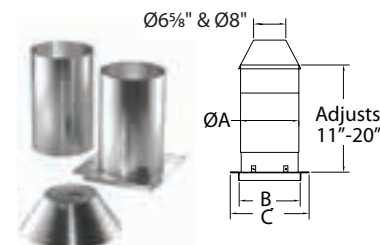

SOME BRANDS ARE ONLY AVAILABLE IN SELECTED AREAS, SEE MAP ON PAGE 4 OR CONTACT YOUR REGIONAL SALES MANGER FOR MORE INFO.

Pricing, model numbers and availability are subject to change without notice. Call for most current information.

Wall Strap

Use to support vent pipe. Provides 1" Clearance.

| SIZE | STOCK # | A | List Price |
|-------------|----------|--------|------------|
| 4" x 6 5/8" | 46DVA-WS | 6 5/8" | \$25.23 |
| 5" x 8" | 58DVA-WS | 8" | \$28.85 |

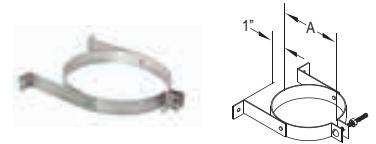

Restrictor Disk

| SIZE | STOCK # | A | B | List Price |
|-------------|------------|--------|---------|------------|
| 4" x 6 5/8" | 46DVA-RD | 5 1/4" | 4 9/16" | \$5.95 |
| 5" x 8" | 58DVA-RD ❖ | 7" | 6" | \$13.22 |



Adjustable Roof Flashing

Use to weather proof the penetration of vent through the roof. Storm collar required.

| SIZE | STOCK # | A | B | C | List Price |
|-------------|----------|--------|---------|---------|------------|
| 4" x 6 5/8" | 46DVA-F6 | 6 3/4" | 19 1/4" | 19 1/4" | \$40.91 |
| 5" x 8" | 58DVA-F6 | 8 1/2" | 21 1/2" | 21 1/2" | \$75.54 |

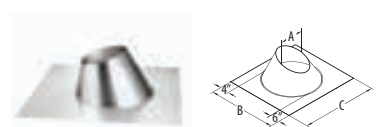

Steep Roof Flashing

| SIZE | STOCK # | A | B | C | List Price |
|-------------|-----------|--------|---------|---------|------------|
| 4" x 6 5/8" | 46DVA-F12 | 6 3/4" | 21 1/2" | 19 1/4" | \$77.61 |
| 5" x 8" | 58DVA-F12 | 8 1/2" | 23 1/2" | 21 1/2" | \$133.94 |

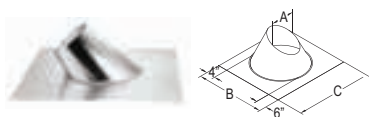

Flat Roof Flashing

| SIZE | STOCK # | A | B | C | D | List Price |
|-------------|----------|--------|---------|-----|----|------------|
| 4" x 6 5/8" | 46DVA-FF | 6 3/4" | 21 1/2" | 12" | 4" | \$61.96 |
| 5" x 8" | 58DVA-FF | 8 1/2" | 23 1/2" | 12" | 4" | \$83.46 |

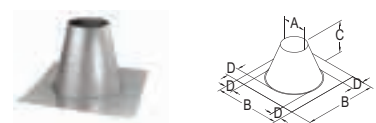

Dead Soft Aluminum Flashing

Use w/ metal or tile roofs.

| SIZE | STOCK # | A | B | C | List Price |
|-------------|------------|--------|---------|-----|------------|
| 4" x 6 5/8" | 46DVA-F6DS | 6 3/4" | 27 1/2" | 24" | \$77.20 |
| 5" x 8" | 58DVA-F6DS | 8 1/2" | 29 1/2" | 24" | \$101.55 |



Storm Collar

Use to maintain a weather tight resistant seal between the pipe and the flashing.

| SIZE | STOCK # | A | B | List Price |
|-------------|----------|--------|---------|------------|
| 4" x 6 5/8" | 46DVA-SC | 6 5/8" | 10 5/8" | \$11.89 |
| 5" x 8" | 58DVA-SC | 8" | 12" | \$19.46 |

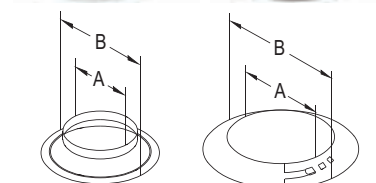

SOME BRANDS ARE ONLY AVAILABLE IN SELECTED AREAS, SEE MAP ON PAGE 4 OR CONTACT YOUR REGIONAL SALES MANGER FOR MORE INFO.

Pricing, model numbers and availability are subject to change without notice. Call for most current information.

❖ – Non Stock Special Order

Goldsboro (Best & Langston) Ph: 888-260-1900 Fax: 919-739-9920

Round Horizontal Termination Cap

Use for through-the-wall terminations.

| SIZE | STOCK # | A | B | C | D | List Price |
|-------------|------------|-----|--------|----------|--------|------------|
| 4" x 6 5/8" | 46DVA-HRCS | 11" | 5 3/4" | 4" | 6 5/8" | \$137.70 |
| 5" x 8" | 58DVA-HRCS | 11" | 5 3/4" | 4 15/16" | 8 1/8" | \$184.74 |

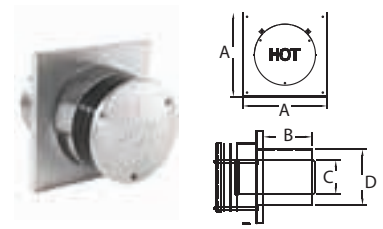

Sconce Termination Cap

| SIZE | STOCK # | A | B | C | D | List Price |
|-------------|-----------|----------|-----|--------|---------|------------|
| 4" x 6 5/8" | 46DVA-HSC | 11 1/16" | 11" | 6 3/8" | 12 3/8" | \$158.26 |
| 5" x 8" | 58DVA-HSC | 11 1/16" | 11" | 6 3/8" | 12 3/8" | \$211.02 |

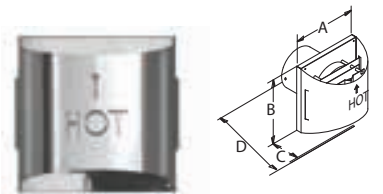

High-Wind Sconce Termination Cap

Includes heat deflector that may be required by appliance manufacturer.

| SIZE | STOCK # | A | B | C | D | List Price |
|-------------|------------|----------|-----|--------|---------|------------|
| 4" x 6 5/8" | 46DVA-HSCH | 11 1/16" | 11" | 6 3/8" | 12 3/8" | \$210.48 |
| 5" x 8" | 58DVA-HSCH | 11 1/16" | 11" | 6 3/8" | 12 3/8" | \$283.06 |

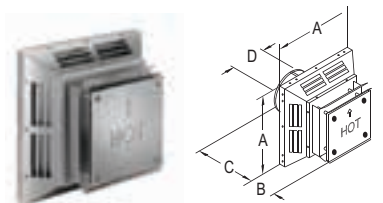

Square Horizontal Termination Cap

| SIZE | STOCK # | A | B | C | D | List Price |
|-------------|----------|---------|--------|---------|--------|------------|
| 4" x 6 5/8" | 46DVA-HC | 13 1/2" | 6 7/8" | 12 1/2" | 6 5/8" | \$237.62 |
| 5" x 8" | 58DVA-HC | 16" | 6 7/8" | 12 1/2" | 8 1/8" | \$270.18 |

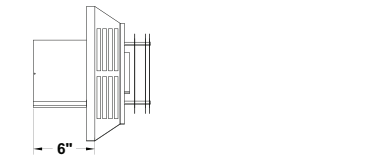

Square Horizontal H2 Termination Cap

Features an adjustable air intake and interchangeable shroud (Shroud is included and required for all installations). Check with appliance manufacturer for approval and air throttle setting.

| SIZE | STOCK # | A | List Price |
|-------------|----------|--------|------------|
| 4" x 6 5/8" | 46DVA-H2 | 6 3/4" | \$213.86 |
| 5" x 8" | 58DVA-H2 | 8 1/8" | \$243.17 |

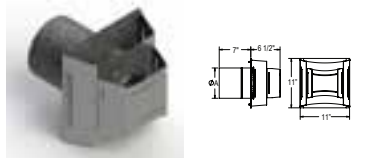

Snorkel Termination Cap

| SIZE | STOCK # | A | B | C | List Price |
|-------------|-------------|-----|---------|-----|------------|
| 4" x 6 5/8" | 46DVA-SNK14 | 10" | 23 3/4" | 14" | \$634.01 |
| 4" x 6 5/8" | 46DVA-SNK36 | 10" | 45 3/4" | 36" | \$725.46 |

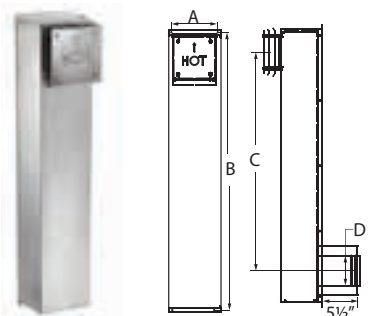

SOME BRANDS ARE ONLY AVAILABLE IN SELECTED AREAS, SEE MAP ON PAGE 4 OR CONTACT YOUR REGIONAL SALES MANGER FOR MORE INFO.

Pricing, model numbers and availability are subject to change without notice. Call for most current information.

High-Wind Termination Cap

Use for vertical terminations only.

| SIZE | STOCK # | A | B | C | D | List Price |
|-------------|-----------|---------|--------|--------|---------|------------|
| 4" x 6 5/8" | 46DVA-VCH | 12 3/8" | 6 5/8" | 7 5/8" | 10 1/2" | \$95.78 |
| 5" x 8" | 58DVA-VCH | 12 3/8" | 8" | 7 5/8" | 10 1/2" | \$113.77 |

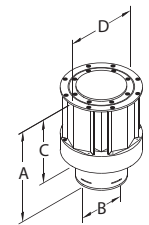

Vertical Wind Guard

Use with high wind termination cap when additional wind protection is needed. Fits both 4" x 6 5/8" and 5" x 8".

| STOCK # | List Price |
|-----------|------------|
| 46DVA-VWG | \$111.66 |



Low-Profile Termination Cap

| SIZE | STOCK # | A | B | C | D | List Price |
|-------------|----------|--------|--------|--------|---------|------------|
| 4" x 6 5/8" | 46DVA-VC | 8 1/4" | 6 5/8" | 3 1/4" | 12 1/2" | \$113.48 |
| 5" x 8" | 58DVA-VC | 8 5/8" | 8" | 7 5/8" | 12 1/2" | \$129.74 |



Co-Axial to Co-Linear Appliance Connector

Use co-linear adaptor for stoves w/ 4" x 6 5/8" co-axial outlets.

| SIZE | STOCK # | A | B | C | D | List Price |
|-------------|-----------|---------|----|--------|--------|------------|
| 4" x 6 5/8" | 46DVA-GCL | 10 1/2" | 3" | 7 1/2" | 7 1/8" | \$184.54 |

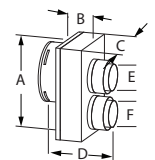

Chimney Liner Termination Kit

Kit includes: Termination connector and flashing. DuraVent Pro 4" x 6 5/8" termination cap, 3" flex, and co-linear flex connectors are sold separately.

| SIZE | STOCK # | A | B | List Price |
|-------------|----------|----|----|------------|
| 4" x 6 5/8" | 46DVA-GK | 3" | 3" | \$199.14 |
| 4" x 6 5/8" | 46DVA-CT | 4" | 3" | \$194.52 |

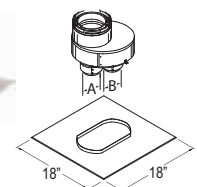

Appliance Adaptor

Attaches to appliance outlet, allowing pipe to easily connect or disconnect.

| SIZE | STOCK # | List Price |
|-------------|-----------|------------|
| 4" x 6 5/8" | 46DVA-ADP | \$60.92 |

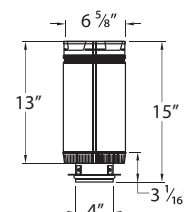

Reducer

| SIZE | REDUCE TO | STOCK # | A | B | List Price |
|---------|-------------|-----------|--------|----|------------|
| 5" x 8" | 4" x 6 5/8" | 58DVA-X46 | 6 5/8" | 8" | \$75.48 |



Co-Linear Kit w/ Flex

Use when installing a direct vent co-linear insert into a masonry chimney.

Kit includes: choice of high-wind termination cap or prairie termination cap; and two pieces of aluminum flex lengths – one red (exhaust), and one green (air intake). See chart for diameters and lengths.

| STOCK # | RED FLEX (Exhaust) | GREEN FLEX (Air Intake) | CAP STYLE | CAP SIZE | List Price |
|-------------|--------------------|-------------------------|-----------|-------------|------------|
| 46DVA-CL33 | 3" x 35' | 3" x 35' | High Wind | 4" x 6 5/8" | \$404.78 |
| 46DVA-CL33H | 3" x 30' | 3" x 4' | High Wind | 4" x 6 5/8" | \$334.99 |
| 46DVA-CL34 | 4" x 35' | 3" x 35' | High Wind | 4" x 6 5/8" | \$404.78 |
| 46DVA-CL33P | 3" x 35' | 3" x 35' | Prairie | 4" x 6 5/8" | \$446.65 |
| 46DVA-CL34P | 4" x 35' | 3" x 35' | Prairie | 4" x 6 5/8" | \$446.65 |



Direct Vent Factory-Built Reline Kit

| CAP SIZE | STOCK# | A (RED FLEX Exhaust) | B (GREEN FLEX Air Intake) | PLATE DIMENSION | CAP STYLE | List Price |
|-------------|-----------------|----------------------|---------------------------|-----------------|-----------|------------|
| 4" x 6 5/8" | 46DVA-CL33KFB | 3" x 35' | 3" x 35' | 14" | High Wind | \$416.45 |
| 4" x 6 5/8" | 46DVA-CL34KFB ❖ | 4" x 35' | 3" x 35' | 14" | High Wind | \$416.45 |

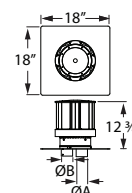

SOME BRANDS ARE ONLY AVAILABLE IN SELECTED AREAS, SEE MAP ON PAGE 4 OR CONTACT YOUR REGIONAL SALES MANGER FOR MORE INFO.

Pricing, model numbers and availability are subject to change without notice. Call for most current information.