

Venting Components – DirectVent Pro

DirectVent Pro

Installation Key			
1	Vertical Termination Cap	9	90° Elbow
2	Storm Collar	10	Horizontal Termination Cap
3	Flashing	11	Snorkel Termination Cap
4	Cathedral Ceiling Support Box	12	Colinear Kit
5	Pipe	13	3" or 4" Flex
6	45° Elbow	14	Co-Axial to Co-Linear Connector
7	Class A Chimney Conversion Kit	15	Masonry Chimney Conversion Kit
8	4" Flex	16	Elbow Strap

Applications

DirectVent Pro is a unitized, coaxial (concentric) venting system designed for use w/ direct vent gas or propane stoves, heaters, and fireplaces.

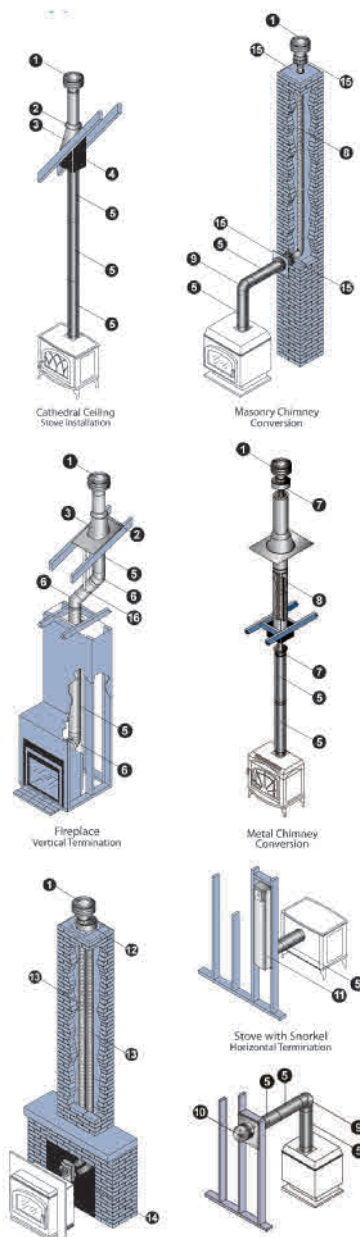
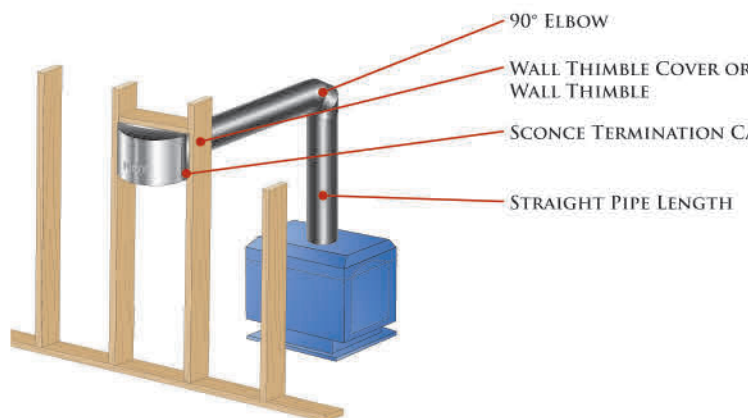

SOME BRANDS ARE ONLY AVAILABLE IN SELECTED AREAS, CONTACT YOUR REGIONAL SALES MANAGER FOR MORE INFO.
 Pricing, model numbers and availability are subject to change without notice. Call for most current information.

Horizontal Termination Kit A

Kit includes: 90° black elbow, ceiling support/wall thimble cover, 24" black pipe, 8 1/2" black pipe extension. Termination cap not included. For 4" x 6 5/8" direct vent. Choose termination cap to complete installation.

SIZE	STOCK #	List Price
4" x 6 5/8"	46DVA-KHA	\$595.17



Horizontal Termination Kit C

Kit includes: 90° black elbow, wall thimble, ceiling support/wall thimble cover, 24" black pipe, 8 1/2" black pipe extension. Termination cap not included. For 4" x 6 5/8" direct vent. Choose termination cap to complete installation.

SIZE	STOCK #	List Price
4" x 6 5/8"	46DVA-KHC	\$703.20



Masonry Chimney Conversion Kit

Kit 46DVA-KMC includes: cap adapter, 18" x 18" flashing, round ceiling support/wall thimble cover, retro connector. For 4" x 6 5/8" direct vent. Termination cap and 4" flex are sold separately.

Kit 46DVA-KCT includes: cap Adapter and an 18" x 18" flashing.

SIZE	STOCK #	List Price
4" x 6 5/8"	46DVA-KMC	\$489.68
4" x 6 5/8"	46DVA-KCT	\$189.27

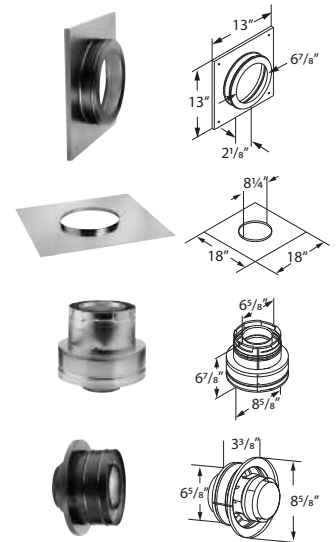

Chimney Conversion Kit

Kits 46DVA-KCA and 46DVA-KCB include: cap adapter and a retro connector. DirectVent Pro 4" x 6 5/8" termination cap and 4" flex are sold separately.

SIZE	STOCK #	A	B	C	List Price
4" x 6 5/8"	46DVA-KCA	6 5/8"	8 5/8"	6 7/8"	\$406.38
4" x 6 5/8"	46DVA-KCB	6 5/8"	10 1/2"	5 7/8"	\$406.38
4" x 6 5/8"	46DVA-KCC	6 5/8"	13"	5 7/8"	\$406.38

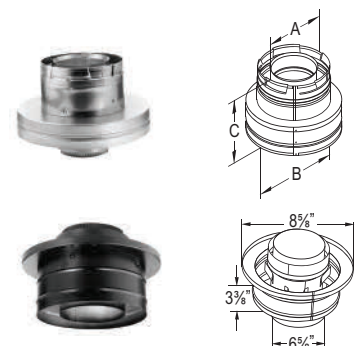

SOME BRANDS ARE ONLY AVAILABLE IN SELECTED AREAS, CONTACT YOUR REGIONAL SALES MANAGER FOR MORE INFO.

Pricing, model numbers and availability are subject to change without notice. Call for most current information.

Venting Components – DirectVent Pro

Pipe Length

SIZE	GALVANIZED	List Price	BLACK	List Price	A
4" x 6 5/8"	46DVA-06	\$53.38	46DVA-06B	\$94.59	6"
4" x 6 5/8"	46DVA-09	\$60.89	46DVA-09B	\$93.60	9"
4" x 6 5/8"	46DVA-12	\$70.33	46DVA-12B	\$103.72	12"
4" x 6 5/8"	46DVA-18	\$83.55	46DVA-18B	\$116.96	18"
4" x 6 5/8"	46DVA-24	\$96.03	46DVA-24B	\$134.42	24"
4" x 6 5/8"	46DVA-36	\$117.27	46DVA-36B	\$164.16	36"
4" x 6 5/8"	46DVA-48	\$140.15	46DVA-48B	\$196.23	48"
4" x 6 5/8"	46DVA-60	\$186.76	46DVA-60B	\$261.48	60"
5" x 8"	58DVA-06	\$62.80	58DVA-06B ❖	\$111.28	6"
5" x 8"	58DVA-09	\$71.65	58DVA-09B ❖	\$170.45	9"
5" x 8"	58DVA-12	\$82.74	58DVA-12B ❖	\$227.27	12"
5" x 8"	58DVA-18	\$98.29	58DVA-18B ❖	\$137.59	18"
5" x 8"	58DVA-24	\$112.96	58DVA-24B	\$158.14	24"
5" x 8"	58DVA-36	\$137.95	58DVA-36B	\$193.13	36"
5" x 8"	58DVA-48	\$164.89	58DVA-48B	\$221.98	48"
5" x 8"	58DVA-60	\$219.72	58DVA-60B	\$307.61	60"

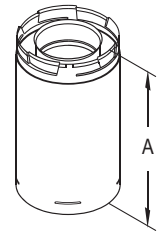

Pipe Extension

8 1/2" pipe adds 3"-7" of length, 16" pipe adds 3-14 1/2" of length, when used with rigid sections of pipe.

SIZE	GALVANIZED	List Price	BLACK	List Price	A	EXTENSION
4" x 6 5/8"	46DVA-08A	\$52.27	46DVA-08AB	\$80.28	8 1/2"	3" – 7"
4" x 6 5/8"	46DVA-16A	\$61.99	46DVA-16AB	\$91.41	16"	3" – 14 1/2"
5" x 8"	58DVA-08A	\$61.55	58DVA-08AB ❖	\$94.54	8 1/2"	3" – 7"
5" x 8"	58DVA-16A	\$77.49	58DVA-16AB ❖	\$114.28	16"	3" – 14 1/2"

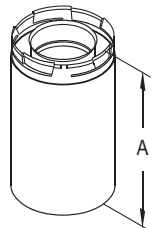

SOME BRANDS ARE ONLY AVAILABLE IN SELECTED AREAS, CONTACT YOUR REGIONAL SALES MANAGER FOR MORE INFO.

Pricing, model numbers and availability are subject to change without notice. Call for most current information.

Adjustable Pipe

SIZE	GALVANIZED	List Price	BLACK	List Price	A	INSTALLED
4" x 6 5/8"	46DVA-17TA	\$95.79	46DVA-17TAB	\$177.04	11" – 17"	9 1/2" – 15 1/2"
4" x 6 5/8"	46DVA-24TA	\$110.12	46DVA-24TAB	\$189.68	17" – 24"	15 1/2" – 22 1/2"
5" x 8"	58DVA-17TA	\$117.29	58DVA-17TAB ❖	\$568.16	11" – 17"	9 1/2" – 15 1/2"
5" x 8"	58DVA-24TA	\$123.29	--	--	17" – 24"	15 1/2" – 22 1/2"

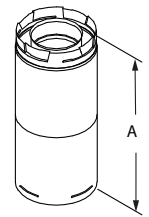

30° Elbow

SIZE	GALVANIZED	List Price	A	B
4" x 6 5/8"	46DVA-E30	\$120.09	5 1/4"	4 7/8"
5" x 8"	58DVA-E30	\$196.58	6 1/8"	5 1/2"

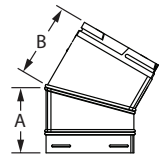

45° Elbow

SIZE	GALVANIZED	List Price	BLACK	List Price	A	B
4" x 6 5/8"	46DVA-E45	\$94.84	46DVA-E45B	\$124.09	5 3/4"	5 1/8"
5" x 8"	58DVA-E45	\$115.75	58DVA-E45B	\$170.73	6 5/8"	6"

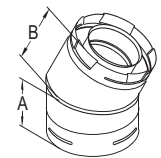

90° Elbow

SIZE	GALVANIZED	List Price	BLACK	List Price	A	B
4" x 6 5/8"	46DVA-E90	\$110.95	46DVA-E90B	\$144.95	6 1/2"	6 1/2"
5" x 8"	58DVA-E90	\$135.00	58DVA-E90B	\$199.12	7 3/8"	7 3/8"

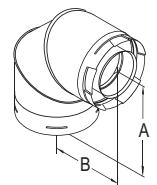

SOME BRANDS ARE ONLY AVAILABLE IN SELECTED AREAS, CONTACT YOUR REGIONAL SALES MANAGER FOR MORE INFO.

Pricing, model numbers and availability are subject to change without notice. Call for most current information.

Venting Components – DirectVent Pro

Elbow Strap

Use for supporting vent pipe between offsets.

SIZE	STOCK #	A	List Price
4" x 6 5/8"	46DVA-ES	6 5/8"	\$30.45
5" x 8"	58DVA-ES	8"	\$38.57

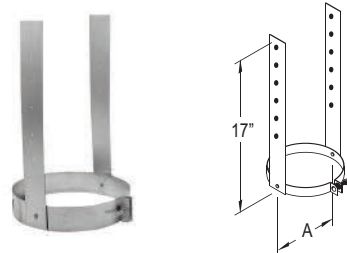

Decorative Cover

Use as a decorative cover for horizontal (through-wall) installation. Fits over the wall thimble face plate. Also used to cover a ceiling support box.

SIZE	STOCK #	A	B	C	List Price
4" x 6 5/8"	46DVA-DC	6 7/8"	13"	13"	\$122.34
5" x 8"	58DVA-DC	8 1/4"	13"	13"	\$140.61

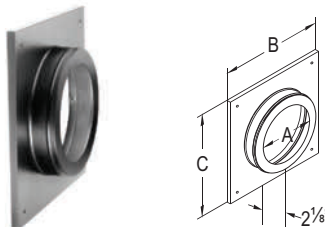

Cathedral Ceiling Support Box

Use to pass through ceiling and support pipe. May be used on vaulted or flat ceilings.

SIZE	STOCK #	A	B	List Price
4" x 6 5/8"	46DVA-CS	6 7/8"	10 5/8"	\$190.29
5" x 8"	58DVA-CS	8 1/4"	10 5/8"	\$237.86

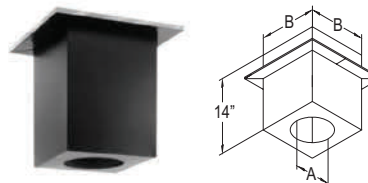

Wall Thimble

Use w/ square horizontal cap only. Provides a complete wall-pass-through and firestop.

SIZE	STOCK #	A	B	C	List Price
4" x 6 5/8"	46DVA-WT	6 3/4"	11"	12"	\$96.03
5" x 8"	58DVA-WT	8 1/4"	12 1/2"	12 1/2"	\$130.39

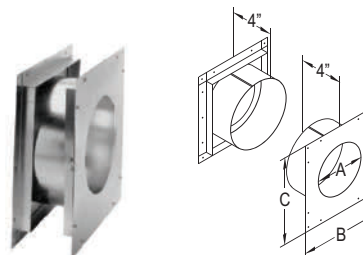

Wall Thimble – Small

Use w/ round horizontal cap, sconce cap and H2 horizontal cap only. Provides a complete wall-pass-through and firestop.

SIZE	STOCK #	A	B	C	List Price
4" x 6 5/8"	46DVA-WTS	6 3/4"	11"	11"	\$87.53
5" x 8"	58DVA-WTS	8 1/4"	11"	11"	\$121.66

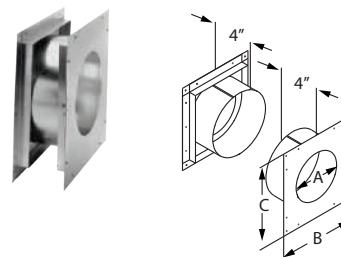

Wall Thimble – Universal

Provides a complete wall-pass-through and interior firestop.

SIZE	STOCK #	A	B	List Price
4" x 6 5/8"	46DVA-WTU	11"	6 3/4"	\$75.88
5" x 8"	58DVA-WTU	11"	8 1/8"	\$90.24

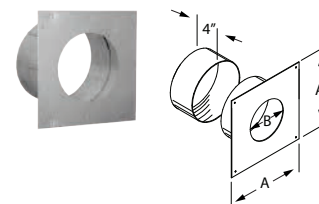

SOME BRANDS ARE ONLY AVAILABLE IN SELECTED AREAS, CONTACT YOUR REGIONAL SALES MANAGER FOR MORE INFO.

Pricing, model numbers and availability are subject to change without notice. Call for most current information.

Wall Firestop

For horizontal (through-wall) installations.

SIZE	STOCK #	A	B	C	List Price
4" x 6 5/8"	46DVA-WFS	6 3/4"	12"	10"	\$99.96
5" x 8"	58DVA-WFS	8 1/4"	12"	10"	\$122.88

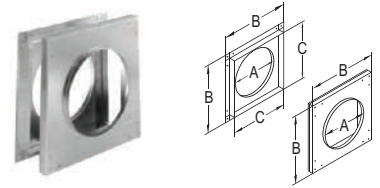

Vinyl Siding Standoff

Use as a heat shield w/ vinyl siding or other temperature sensitive materials, to help prevent warping and or melting of the material. Use only on horizontal terminations.

SIZE	STOCK #	A	B	C	List Price
4" x 6 5/8"	46DVA-VSS	6 3/4"	17 1/2"	13 1/2"	\$126.86
5" x 8"	58DVA-VSS	8 1/4"	19 7/8"	15 3/4"	\$196.73

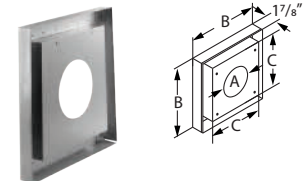

Vinyl Siding Standoff Kit

SIZE	STOCK #	A	B	C	List Price
4" x 6 5/8"	46DVA-VSK	15 1/4"	13 1/4"	3"	\$94.26
5" x 8"	58DVA-VSK	15 1/4"	13 1/4"	3"	\$104.53

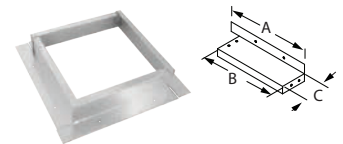

Vinyl Siding Standoff Kit - Small

SIZE	STOCK #	A	B	C	List Price
4" x 6 5/8"	46DVA-VSKS	12 7/8"	10 7/8"	3"	\$82.86

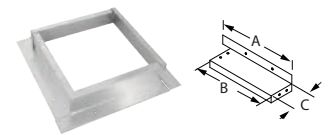

Vinyl Siding Standoff Box

SIZE	STOCK #	List Price
4" x 6 5/8" & 5/8"	DVA-BVS	\$94.44

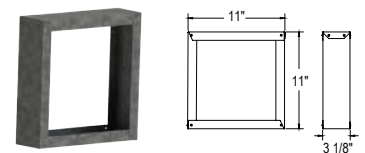

Ceiling Firestop

Required for multi-story vertical installations at the second floor and any subsequent floors.

SIZE	STOCK #	A	B	C	List Price
4" x 6 5/8"	46DVA-FS	6 3/4"	11"	9"	\$23.14
5" x 8"	58DVA-FS	8 1/4"	12 1/2"	10 1/2"	\$28.92

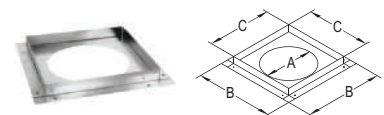

Attic Insulation Shield

Required for installations that pass through an attic to prevent insulation and debris from accumulating near the vent.

SIZE	STOCK #	A	B	C	List Price
4" x 6 5/8"	46DVA-IS	8 3/4"	8 15/16"	11"	\$168.82
5" x 8"	58DVA-IS	10 3/4"	10 15/16"	13"	\$211.02

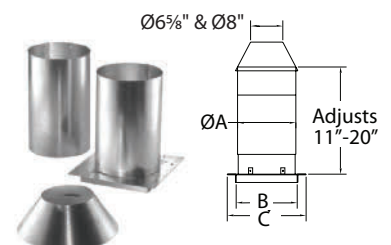

SOME BRANDS ARE ONLY AVAILABLE IN SELECTED AREAS, CONTACT YOUR REGIONAL SALES MANAGER FOR MORE INFO.

Pricing, model numbers and availability are subject to change without notice. Call for most current information.

Venting Components – DirectVent Pro

Wall Strap

Use to support vent pipe. Provides 1" Clearance.

SIZE	STOCK #	A	List Price
4" x 6 5/8"	46DVA-WS	6 5/8"	\$41.76
5" x 8"	58DVA-WS	8"	\$47.57

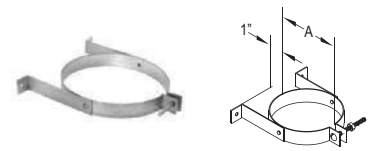

Restrictor Disk

SIZE	STOCK #	A	B	List Price
4" x 6 5/8"	46DVA-RD ❖	5 1/4"	4 9/16"	\$9.82
5" x 8"	58DVA-RD ❖	7"	6"	\$21.79



Adjustable Roof Flashing

Use to weather proof the penetration of vent through the roof. Storm collar required. For pitches of 0/12 - 6/12.

SIZE	STOCK #	A	B	C	List Price
4" x 6 5/8"	46DVA-F6	6 3/4"	19 1/4"	19 1/4"	\$67.46
5" x 8"	58DVA-F6	8 1/2"	21 1/2"	21 1/2"	\$124.55

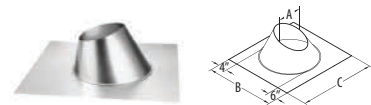

Steep Roof Flashing

SIZE	STOCK #	A	B	C	List Price
4" x 6 5/8"	46DVA-F12	6 3/4"	21 1/2"	19 1/4"	\$127.98
5" x 8"	58DVA-F12	8 1/2"	23 1/2"	21 1/2"	\$220.86

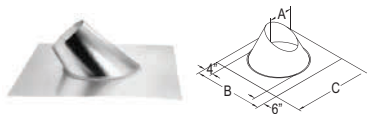

Flat Roof Flashing

SIZE	STOCK #	A	B	C	D	List Price
4" x 6 5/8"	46DVA-FF	6 3/4"	21 1/2"	12"	4"	\$102.17
5" x 8"	58DVA-FF	8 1/2"	21 1/2"	12"	4"	\$137.62



Dead Soft Aluminum Flashing

Use w/ metal or tile roofs.

SIZE	STOCK #	A	B	C	List Price
4" x 6 5/8", 0/12 - 6/12	46DVA-F6DS	6 3/4"	27 1/2"	24"	\$127.29
5" x 8", 0/12 - 6/12	58DVA-F6DS	8 1/2"	29 1/2"	24"	\$167.45
4" x 6 5/8", 7/12 - 12/12	46DVA-F12DS	8 3/4"	22"	25"	\$187.55
5" x 8", 7/12 - 12/12	58DVA-F12DS	8 1/2"	24 3/4"	27"	\$311.39

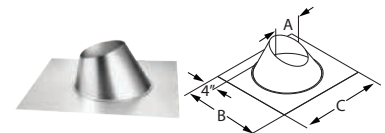

Universal Rubber Boot Flashing Kit



SIZE	STOCK #	List Price
23" x 23"	URBAK	\$578.66



SOME BRANDS ARE ONLY AVAILABLE IN SELECTED AREAS, CONTACT YOUR REGIONAL SALES MANAGER FOR MORE INFO.

Pricing, model numbers and availability are subject to change without notice. Call for most current information.

Storm Collar

Use to maintain a weather tight resistant seal between the pipe and the flashing.

SIZE	STOCK #	A	B	List Price
4" x 6 5/8"	46DVA-SC	6 5/8"	10 5/8"	\$19.61
5" x 8"	58DVA-SC	8"	12"	\$32.10

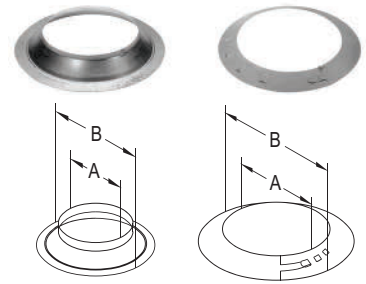

Round Horizontal Termination Cap

Use for through-the-wall terminations.

SIZE	STOCK #	A	B	C	D	List Price
4" x 6 5/8"	46DVA-HRCS	11"	5 3/4"	4"	6 5/8"	\$227.05
5" x 8"	58DVA-HRCS	11"	5 3/4"	4 15/16"	8 1/8"	\$304.61

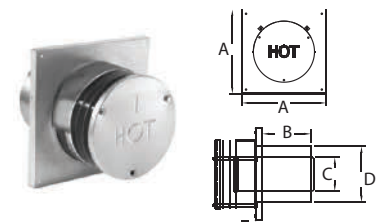

Sconce Termination Cap

SIZE	STOCK #	A	B	C	D	List Price
4" x 6 5/8"	46DVA-HSC	11 1/16"	11"	6 3/8"	12 3/8"	\$260.95
5" x 8"	58DVA-HSC	11 1/16"	11"	6 3/8"	12 3/8"	\$347.61

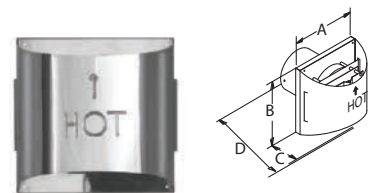

High-Wind Sconce Termination Cap

Includes heat deflector that may be required by appliance manufacturer.

SIZE	STOCK #	A	B	C	D	List Price
4" x 6 5/8"	46DVA-HSCH	11 1/16"	11"	6 3/8"	12 3/8"	\$347.07
5" x 8"	58DVA-HSCH	11 1/16"	11"	6 3/8"	12 3/8"	\$466.74

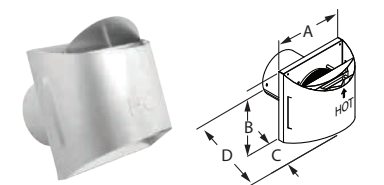

Square Horizontal Termination Cap

SIZE	STOCK #	A	B	C	D	List Price
4" x 6 5/8"	46DVA-HC	13 1/2"	6 7/8"	12 1/2"	6 5/8"	\$391.82
5" x 8"	58DVA-HC	16"	6 7/8"	12 1/2"	8 1/8"	\$445.50

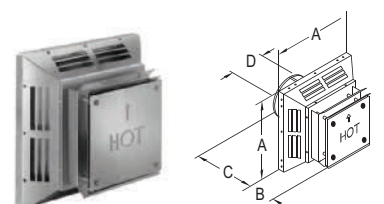

Square Horizontal H2 Termination Cap

Features an adjustable air intake and interchangeable shroud (Shroud is included and required for all installations). Check with appliance manufacturer for approval and air throttle setting.

SIZE	STOCK #	A	List Price
4" x 6 5/8"	46DVA-H2	6 3/4"	\$352.64
5" x 8"	58DVA-H2	8 1/8"	\$400.96

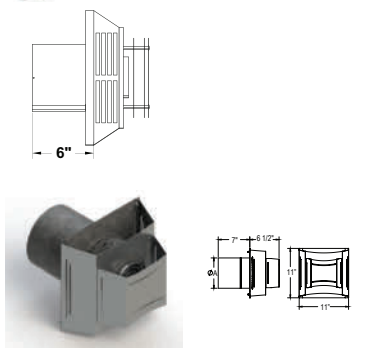

SOME BRANDS ARE ONLY AVAILABLE IN SELECTED AREAS, CONTACT YOUR REGIONAL SALES MANAGER FOR MORE INFO.

Pricing, model numbers and availability are subject to change without notice. Call for most current information.

Venting Components – DirectVent Pro

Snorkel Termination Cap

SIZE	STOCK #	A	B	C	List Price
4" x 6 5/8"	46DVA-SNK14	10"	23 3/4"	14"	\$1,045.42
4" x 6 5/8"	46DVA-SNK36	10"	45 3/4"	36"	\$1,196.20

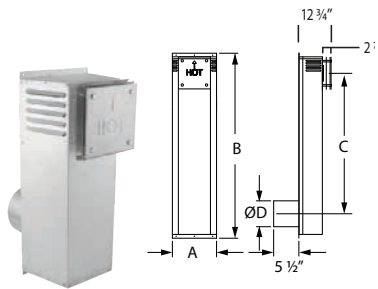

Horizontal Windguard

Use with through-the-wall termination cap where high winds are present.

SIZE	STOCK #	List Price
4" x 6" & 5" x 8"	46DVA-WG ❖	\$258.82

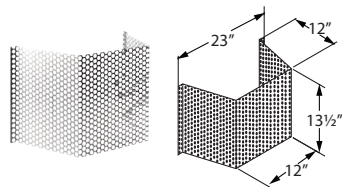

High-Wind Termination Cap

Use for vertical terminations only.

SIZE	STOCK #	A	B	C	D	List Price
4" x 6 5/8"	46DVA-VCH	12 3/8"	6 5/8"	7 5/8"	10 1/2"	\$157.94
5" x 8"	58DVA-VCH	12 3/8"	8"	7 5/8"	10 1/2"	\$187.60

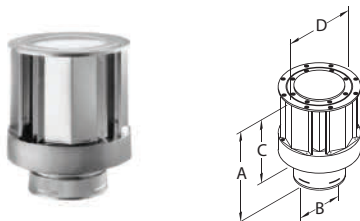

Vertical Wind Guard

Use with high wind termination cap when additional wind protection is needed.

SIZE	STOCK #	List Price
4" x 6" & 5" x 8"	46DVA-VWG	\$184.12

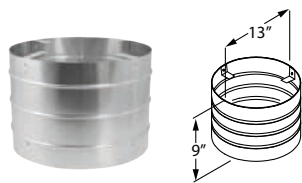

Low-Profile Termination Cap

SIZE	STOCK #	A	B	C	D	List Price
4" x 6 5/8"	46DVA-VC	8 1/4"	6 5/8"	3 1/4"	12 1/2"	\$187.12
5" x 8"	58DVA-VC	8 5/8"	8"	3 1/4"	12 1/2"	\$213.93

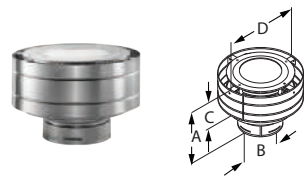

Concentric Flex

SIZE	STOCK #	LENGTH	List Price
4" x 7"	46DVA-36FF	36"	\$252.04
	46DVA-60FF	60"	\$329.05
	46DVA-120FF	120"	\$574.09
5" x 8"	58DVA-36FF ❖	36"	\$294.05
	58DVA-60FF	60"	\$392.06
	58DVA-120FF ❖	120"	\$679.11



SOME BRANDS ARE ONLY AVAILABLE IN SELECTED AREAS, CONTACT YOUR REGIONAL SALES MANAGER FOR MORE INFO.

Pricing, model numbers and availability are subject to change without notice. Call for most current information.

Co-Axial to Co-Linear Appliance Connector

Co-linear Adapter for use with appliances with 4" x 6 5/8" co-axial outlets. Comes pre-painted in black for use with free-standing stoves. Uses aluminum for both intake and exhaust.

SIZE	STOCK #	EXHAUST	INTAKE	A	B	C	D	List Price
4" x 6 5/8"	46DVA-CLAA ❖	3"	3"	8 7/8"	7 1/8"	3"	3"	\$189.78
4" x 6 5/8"	46DVA-34CLAA ❖	4"	3"	8 7/8"	8 1/4"	4"	3"	\$240.85

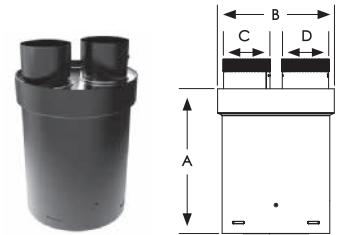

Co-Axial to Co-Linear Appliance Connector

Use co-linear Adapter for stoves w/ 4" x 6 5/8" co-axial outlets. Uses aluminum for both intake and exhaust.

SIZE	STOCK #	A	B	C	D	List Price
4" x 6 5/8"	46DVA-GCL	10 1/2"	3"	7 1/2"	7 1/8"	\$304.28
4" x 6 5/8"	46DVA-TCL	10 1/2"	3"	7 1/2"	6 3/8"	\$304.28
4" x 6 5/8"	46DVA-VCL	10 1/2"	3"	7 1/2"	8 5/8"	\$304.28

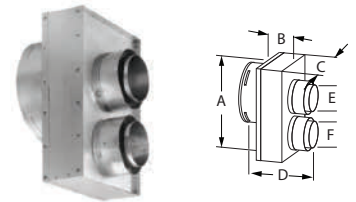

Chimney Liner Termination Kit

Kit includes: Termination connector and top plate flashing. DirectVent Pro 4" x 6 5/8" termination caps, 3" flex, and co-linear flex connectors are sold separately.

SIZE	STOCK #	A	B	List Price
4" x 6 5/8"	46DVA-CLTA ❖	8 7/8"	7 1/8"	\$216.29
4" x 6 5/8"	46DVA-34CLTA ❖	8 7/8"	8 1/4"	\$261.70

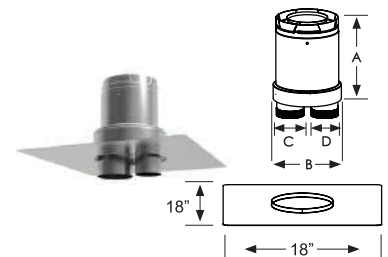

Chimney Liner Termination Kit

Kit includes: Termination connector and flashing. Directvent Pro 4" x 6 5/8" termination cap, 3" flex, and co-linear flex connectors are sold separately.

SIZE	STOCK #	A	B	List Price
4" x 6 5/8"	46DVA-GK	3"	3"	\$328.36
4" x 6 5/8"	46DVA-CT	4"	3"	\$320.74

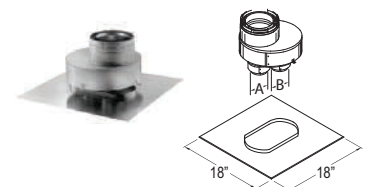

Co-Linear Flex Connector

SIZE	STOCK #	List Price
4" x 6 5/8"	46DVA-ADF	\$71.96

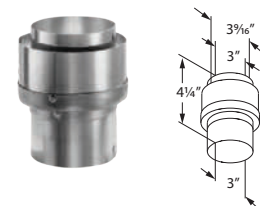

SOME BRANDS ARE ONLY AVAILABLE IN SELECTED AREAS, CONTACT YOUR REGIONAL SALES MANAGER FOR MORE INFO.

Pricing, model numbers and availability are subject to change without notice. Call for most current information.

Venting Components – DirectVent Pro

Appliance Adapter

Attaches to appliance outlet, allowing pipe to easily connect or disconnect.

SIZE	STOCK #	List Price
4" x 6 5/8"	46DVA-ADP	\$100.45

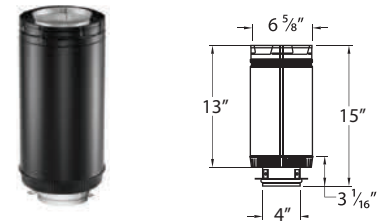

Reducer

SIZE	REDUCE TO	STOCK #	A	B	List Price
5" x 8"	4" x 6 5/8"	58DVA-X46	6 5/8"	8"	\$124.47

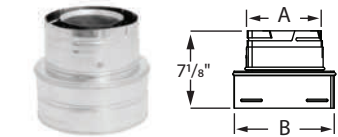

Co-Linear Kit w/ Flex

Use when installing a direct vent co-linear insert into a masonry chimney.

Kit includes: choice of high-wind termination cap or prairie termination cap; and two pieces of aluminum flex lengths – one red (exhaust), and one green (air intake).

STOCK #	RED FLEX (Exhaust)	GREEN FLEX (Air Intake)	CAP STYLE	CAP SIZE	List Price
46DVA-CL33	3" x 35'	3" x 35'	High Wind	4" x 6 5/8"	\$667.44
46DVA-CL33H	3" x 30'	3" x 4'	High Wind	4" x 6 5/8"	\$552.36
46DVA-CL34	4" x 35'	3" x 35'	High Wind	4" x 6 5/8"	\$667.44
46DVA-CL33P	3" x 35'	3" x 35'	Prairie	4" x 6 5/8"	\$736.48
46DVA-CL34P	4" x 35'	3" x 35'	Prairie	4" x 6 5/8"	\$736.48

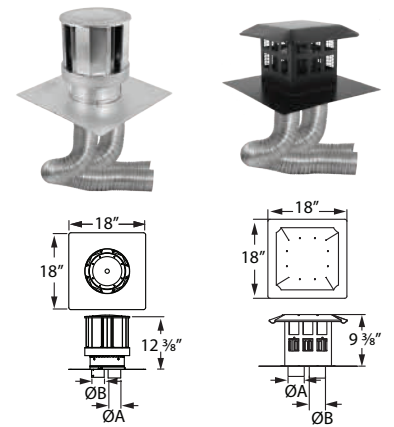

Direct Vent Factory-Built Reline Kit

Use when installing a direct vent Co-Linear insert into an existing factory-built chimney.

Kit Includes: High-wind termination cap, two pieces of aluminum flex lengths and 4 hose clamps

CAP SIZE	STOCK#	A (RED FLEX Exhaust)	B (GREEN FLEX Air Intake)	PLATE DIMENSION	CAP STYLE	List Price
4" x 6 5/8"	46DVA-CL33KFB	3" x 35'	3" x 35'	14"	High Wind	\$686.68
4" x 6 5/8"	46DVA-CL34KFB	4" x 35'	3" x 35'	14"	High Wind	\$686.68

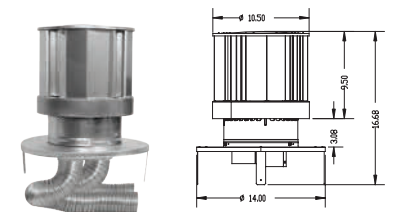

Horizontal Vent Kit for DV Inserts

Kit Includes: Co-Linear termination, 2 - 3" x 10" aluminum flex lengths and hardware.

SIZE	STOCK #	List Price
4" x 6 5/8", 3 x 3	46DVA-HCL33	\$440.24
4" x 6 5/8", 3 x 4	46DVA-HCL34	\$440.24

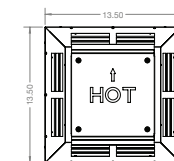
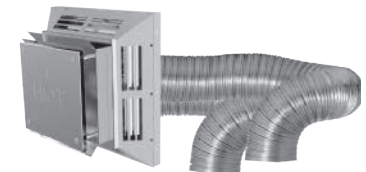

SOME BRANDS ARE ONLY AVAILABLE IN SELECTED AREAS, CONTACT YOUR REGIONAL SALES MANAGER FOR MORE INFO.

Pricing, model numbers and availability are subject to change without notice. Call for most current information.