

Venting Components – PelletVent Pro

Pellevent Pro

Typical Installation

Installation Key			
1	Vertical Cap	10	Horizontal Cap
2	Storm Collar	11	Wall Thimble
3	Flashing	12	Ceiling Support Firestop Spacer
4	Cathedral Ceiling Support Box	13	Tee w/ Clean-Out Tee Cap
5	Straight Length Pipe	14	Wall Strap
6	45° Elbow	15	Attic Insulation Shield
7	Appliance Adapter	16	Prairie Termination Cap
8	Flexible Length	17	CAS Adjustable Wall Channel
9	90° Elbow		

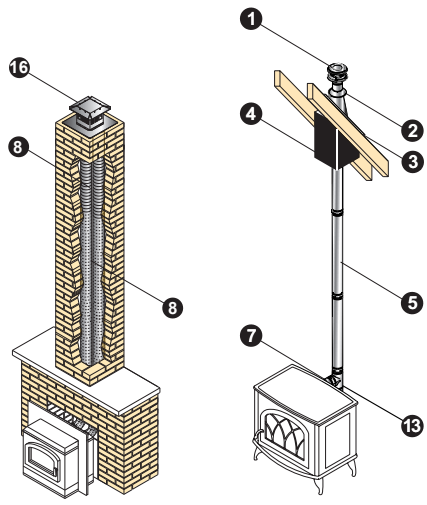

Co-Linear SS Flex Installation for Pellet Inserts

Cathedral Ceiling Stove Installation

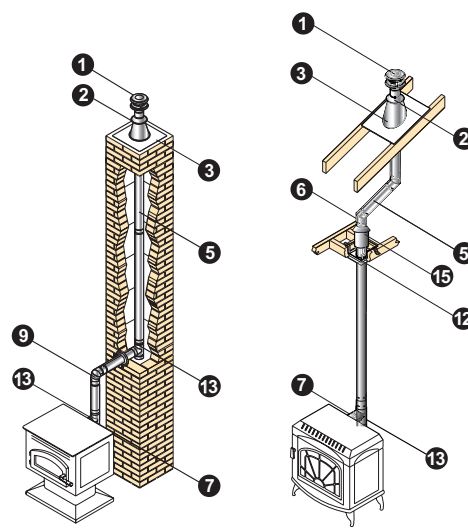

Masonry Chimney Relining with Rigid Pipe

Attic Offset

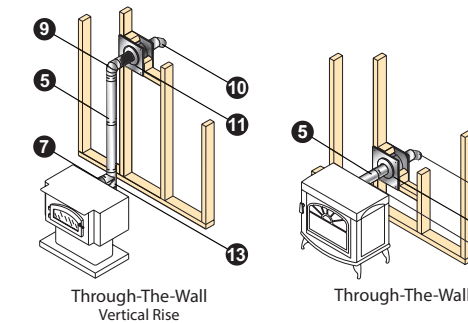

Through-The-Wall Vertical Rise

Through-The-Wall

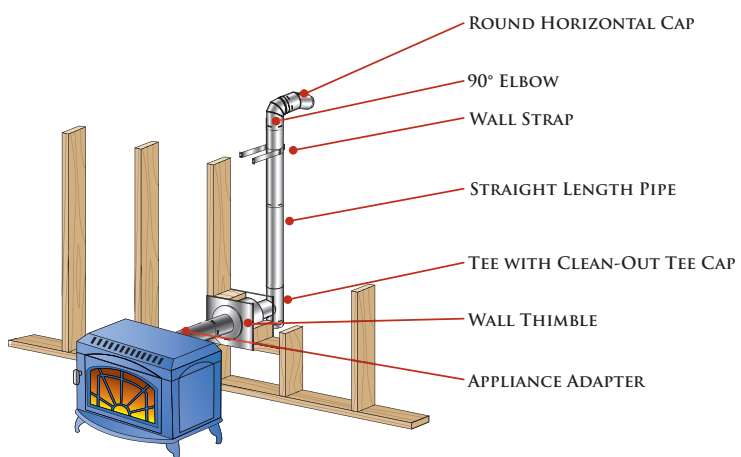

SOME BRANDS ARE ONLY AVAILABLE IN SELECTED AREAS, CONTACT YOUR REGIONAL SALES MANAGER FOR MORE INFO. Pricing, model numbers and availability are subject to change without notice. Call for most current information.

Horizontal Kit

Kit includes: round horizontal cap, wall thimble, and appliance Adapter. Pipe lengths not included. 4" kit includes a 3"-4" appliance Adapter/increaser, painted black.

SIZE	STOCK #	List Price
3"	3PVP-KHA	\$369.97
4"	4PVP-KHA ❖	\$461.61



Vertical Kit – Flat Ceiling

Kit includes: vertical cap, storm collar, ceiling support firestop spacer, adjustable flashing, and appliance Adapter. Pipe lengths not included. 4" kit includes a 3"-4" appliance Adapter/increaser, painted black. Support clamp included.

SIZE	STOCK #	List Price
3"	3PVP-KVA ❖	\$491.55
4"	4PVP-KVA ❖	\$528.54



Fresh Air Intake Kit

Kit includes: faceplate w/ screen, detector, aluminum flex, and two clamps.

STOCK #	List Price
3PVP-AIK	\$104.38
4PVP-AIK ❖	\$132.81

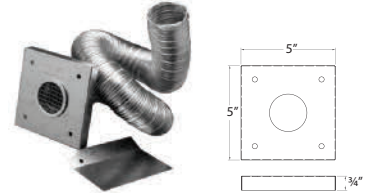

Fresh Air Inlet Increaser

Use to increase an insert's 2" air inlet to connect to 3" aluminum flex.

STOCK #	List Price
3PVP-INC ❖	\$87.02

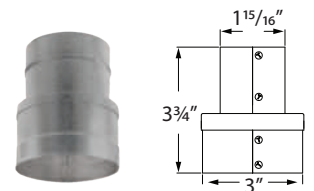

SOME BRANDS ARE ONLY AVAILABLE IN SELECTED AREAS, CONTACT YOUR REGIONAL SALES MANAGER FOR MORE INFO.

Pricing, model numbers and availability are subject to change without notice. Call for most current information.

Venting Components – PelletVent Pro

Straight Length Pipe

SIZE	3"	List Price	4"	List Price
6"	3PVP-06	\$48.87	4PVP-06	\$52.29
6" BLACK	3PVP-06B	\$68.68	4PVP-06B	\$85.35
12"	3PVP-12	\$70.00	4PVP-12	\$74.77
12" BLACK	3PVP-12B	\$91.95	4PVP-12B	\$118.11
24"	3PVP-24	\$92.48	4PVP-24	\$116.79
24" BLACK	3PVP-24B	\$114.93	4PVP-24B	\$159.33
36"	3PVP-36	\$126.83	4PVP-36	\$151.67
36" BLACK	3PVP-36B	\$143.48	4PVP-36B	\$186.84
60"	3PVP-60	\$181.28	4PVP-60	\$205.59
60" BLACK	3PVP-60B	\$214.85	4PVP-60B ❖	\$247.60

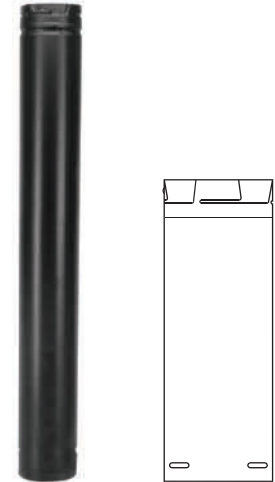

Pipe Extension

12" pipe adds 3" - 10" of length, 18" pipe adds 3" - 16" of length, when used with rigid sections of pipe.

SIZE	STOCK #	A	List Price
3"	3PVP-12A	3" - 10"	95.12
3" BLACK	3PVP-12AB	3" - 10"	\$113.61
3"	3PVP-18A	3" - 16"	\$146.12
3" BLACK	3PVP-18AB	3" - 16"	\$174.66
3"	3PVP-48A	4" - 46"	\$191.48
3" BLACK	3PVP-48AB ❖	4" - 46"	\$251.32
4"	4PVP-12A	3" - 10"	\$105.17
4" BLACK	4PVP-12AB	3" - 10"	\$149.29
4"	4PVP-18A ❖	3" - 16"	\$161.72
4" BLACK	4PVP-18AB ❖	3" - 16"	\$229.64



Increaser

Use to transition from 3" to a 4" pipe.

SIZE	STOCK #	List Price
3" - 4"	3PVP-X4	\$119.94

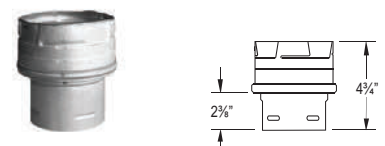

SOME BRANDS ARE ONLY AVAILABLE IN SELECTED AREAS, CONTACT YOUR REGIONAL SALES MANAGER FOR MORE INFO.

Pricing, model numbers and availability are subject to change without notice. Call for most current information.

Flex Pipe - 60" Flex Section

Use for offsetting rigid pipe around smoke shelf in masonry chimney only.

SIZE	STOCK #	List Price
3"	3PVP-60F ❖	\$311.57
4"	4PVP-60F ❖	\$445.83



Flex Trim Collar

Use to connect pelletvent pro rigid pipe to a masonry chimney w/ SS flexible relining.

SIZE	STOCK #	A	B	List Price
3"	3PVP-FTC	3 3/8"	8 1/2"	\$131.92
4"	4PVP-FTC ❖	4 5/8"	8 1/2"	\$125.92

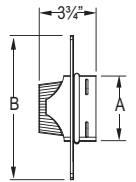

Female Flex Adapter

Use to connect pelletvent pro to Bioflex when relining a masonry chimney.

SIZE	STOCK #	List Price
3"	3PVP-ADFF ❖	\$47.97
4"	4PVP-ADFF ❖	\$39.61

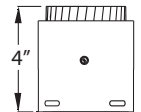

Male Flex Adapter

Use to connect pelletvent pro when relining a masonry chimney.

SIZE	STOCK #	List Price
3"	3PVP-ADFM ❖	\$65.97
4"	4PVP-ADFM ❖	\$71.95

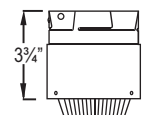

Quick Release Adapter

Use to attach appliance outlet allowing for easy pipe connection.

SIZE	STOCK #	A	B	List Price
3"	3PVP-ADS ❖	3"	3 1/2"	\$83.95
4"	4PVP-ADS ❖	4"	3 1/2"	\$95.96

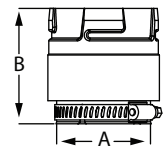

SOME BRANDS ARE ONLY AVAILABLE IN SELECTED AREAS, CONTACT YOUR REGIONAL SALES MANAGER FOR MORE INFO.

Pricing, model numbers and availability are subject to change without notice. Call for most current information.

Venting Components – PelletVent Pro

Appliance Adapter

Use to attach to appliance outlet allowing for easy pipe connection.

SIZE	STOCK #	List Price
3"	3PVP-AD	\$38.03
3" BLACK	3PVP-ADB	\$57.06
4"	4PVP-AD	\$41.20
4" BLACK	4PVP-ADB ❖	\$107.94

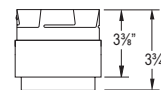

Appliance Adapter/Increaser

SIZE	STOCK #	List Price
3"	3PVP-X4AD	\$138.99
3" BLACK	3PVP-X4ADB ❖	\$181.00



45° Elbow

Offsets obstructions as needed. Elbows swivel 360° at base, angle not adjustable.

SIZE	STOCK #	A	B	List Price
3"	3PVP-E45	3 7/8"	4"	\$123.66
3" BLACK	3PVP-E45B	3 7/8"	4"	\$137.92
4"	4PVP-E45	3 7/8"	4"	\$140.05
4" BLACK	4PVP-E45B	3 7/8"	4"	\$174.15

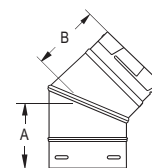

90° Elbow

SIZE	STOCK #	A	B	List Price
3"	3PVP-E90	5 1/2"	5 1/2"	\$154.59
3" BLACK	3PVP-E90B	5 1/2"	5 1/2"	\$174.15
4"	4PVP-E90	5 1/2"	5 1/2"	\$194.50
4" BLACK	4PVP-E90B	5 1/2"	5 1/2"	\$226.72

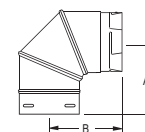

Single Tee w/ Clean-Out Tee Cap

Use for a 90° offset. Branch swivels for alignment.

SIZE	STOCK #	A	B	C	List Price
3"	3PVP-T1	8 1/2"	4 3/8"	4 1/4"	\$207.19
3" BLACK	3PVP-TB1	8 1/2"	4 3/8"	4 1/4"	\$225.15
4"	4PVP-T1	9 5/8"	4 7/8"	4 3/4"	\$216.70
4" BLACK	4PVP-TB1	9 5/8"	4 7/8"	4 3/4"	\$239.94

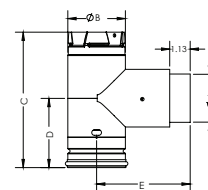

SOME BRANDS ARE ONLY AVAILABLE IN SELECTED AREAS, CONTACT YOUR REGIONAL SALES MANAGER FOR MORE INFO.

Pricing, model numbers and availability are subject to change without notice. Call for most current information.

Increaser Tee w/ Clean-Out Tee Cap

Attaches 3" pipe to branch and 4" pipe to body. Use for a 90° offset.

SIZE	STOCK #	A	B	C	List Price
4"	4PVP-T31	9"	4 1/4"	5 3/5"	\$210.86
4" BLACK	4PVP-T3B1	9"	4 1/4"	5 3/5"	\$236.52

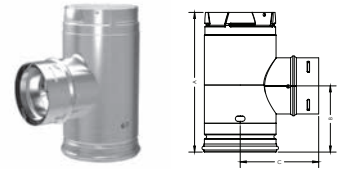

Adapter Tee w/ Clean-Out Tee Cap

Use for a 90° offset. Attaches directly to appliance as an Adapter

SIZE	STOCK #	A	B	C	D	E	List Price
3"	3PVP-TAD1	3"	3 5/8"	8 1/2"	4 3/8"	5 3/4"	\$207.19
3" BLACK	3PVP-TADB1	3"	3 5/8"	8 1/2"	4 3/8"	5 3/4"	\$225.14
4"	4PVP-TAD1 ❖	4"	4 5/8"	9 5/8"	4 7/8"	6 3/8"	\$216.71

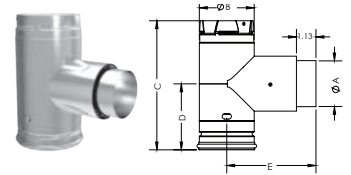

Increaser Adapter Tee w/ Clean-Out Tee Cap

Use for a 90° offset. Attaches directly to appliance as an Adapter. Converts a 3" appliance to a 4" Pellet Vent Pro System.

SIZE	STOCK #	List Price
3"	3PVP-TADX41 ❖	\$220.81

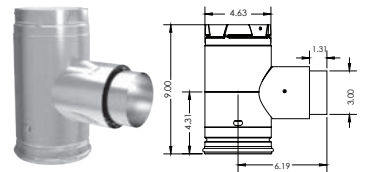

SOME BRANDS ARE ONLY AVAILABLE IN SELECTED AREAS, CONTACT YOUR REGIONAL SALES MANAGER FOR MORE INFO.

Pricing, model numbers and availability are subject to change without notice. Call for most current information.

❖ – Non Stock Special Order - NO RETURNS or CANCELLATIONS

RMI Ph: 800-628-5044

raymurray.com

Venting Components – PelletVent Pro

Clean-Out Tee Cap

Use as a replacement clean-out tee cap.

SIZE	STOCK #	List Price
3"	3PVP-CO1	\$77.95
4"	4PVP-CO1 ❖	\$77.95

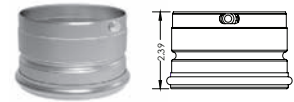

Wall Thimble

Use for through-the-wall installations. Fits between standard wall studs.

SIZE	STOCK #	A	List Price
3"	3PVP-WT	3 3/4"	\$132.11
4"	4PVP-WT	4 3/4"	\$141.90

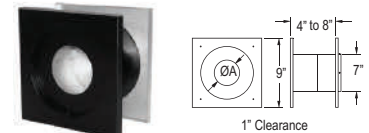

Wall Thimble Air Intake Kit

Allows outside fresh air for combustion through the wall thimble without having to cut a second hole into the wall.

SIZE	FLEX	STOCK #	List Price
3"	2"	3PVP-WTI	\$308.93
4"	2"	4PVP-WTI	\$331.91

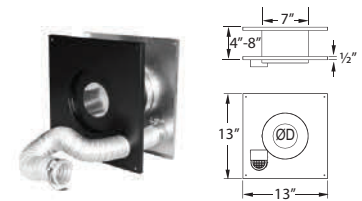

Ceiling Support Firestop Spacer

Required where vent passes through ceiling.

SIZE	STOCK #	A	List Price
3"	3PVP-FS	3 3/4"	\$101.21
4"	4PVP-FS	4 3/4"	\$118.11

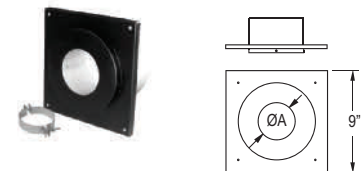

SOME BRANDS ARE ONLY AVAILABLE IN SELECTED AREAS, CONTACT YOUR REGIONAL SALES MANAGER FOR MORE INFO.

Pricing, model numbers and availability are subject to change without notice. Call for most current information.

Wall Strap

Use to support vent pipe or tee sections. Provides 1" clearance.

SIZE	STOCK #	A	List Price
3"	3PVP-WS	3 5/8"	\$47.29
4"	4PVP-WS ❖	4 5/8"	\$51.25

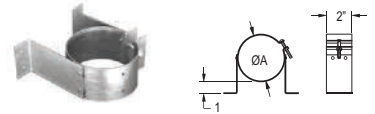

Adjustable Wall Strap

Use to support vent pipe or tee sections. Adjusts to provide 1" - 3" clearance.

SIZE	STOCK #	A	List Price
3"	3PVP-WSA	3 5/8"	\$51.50
4"	4PVP-WSA	4 5/8"	\$55.74

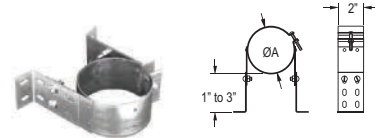

Wall Strap Extension

Use with adjustable wall strap to increase extension from wall. Fits both 3" & 4" adjustable wall strap.

SIZE	STOCK #	List Price
3"	3PVP-WSA-EXT ❖	\$25.35



Cathedral Ceiling Support Box

Use to support pipe. Trim and clamp included. May be used on flat ceilings.

SIZE	STOCK #	A	List Price
3"	3PVP-CS	3 3/4"	\$209.88
4"	4PVP-CS ❖	4 3/4"	\$209.88

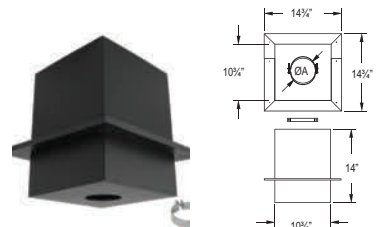

House Shield

Use to protect exterior of structure from blower discharge in horizontal venting applications.

SIZE	STOCK #	A	List Price
3"	3PVP-HS	3 3/4"	\$52.82
4"	4PVP-HS ❖	4 3/4"	\$77.95

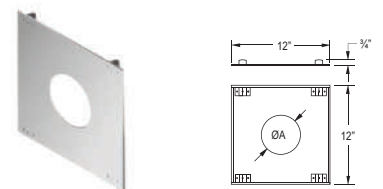

SOME BRANDS ARE ONLY AVAILABLE IN SELECTED AREAS, CONTACT YOUR REGIONAL SALES MANAGER FOR MORE INFO.

Pricing, model numbers and availability are subject to change without notice. Call for most current information.

Venting Components – PelletVent Pro

Attic Insulation Shield

Required for installations that pass through an attic to prevent insulation and debris from accumulating near the vent.

SIZE	STOCK #	List Price
3"	3PVP-IS	\$106.49
4"	4PVP-IS ❖	\$106.49

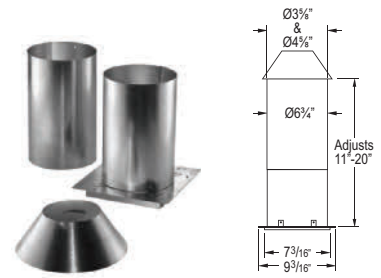

Adjustable Roof Flashing

Use to weather proof the penetration of vent pipe through the roof.

SIZE	STOCK #	A	List Price
3"	3PVP-F6	3 3/4"	\$39.61
4"	4PVP-F6	4 3/4"	\$44.12

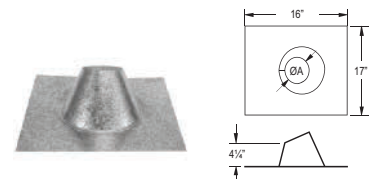

Tall Cone Roof Flashing

SIZE	STOCK #	A	List Price
3"	3PVP-FF ❖	3 3/4"	\$52.82
4"	4PVP-FF ❖	4 3/4"	\$58.38

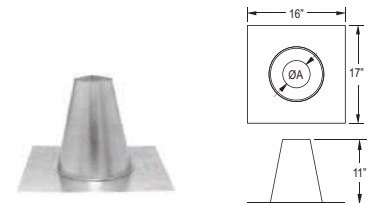

DSA Roof Flashing

SIZE	STOCK #	A	B	C	List Price
3", 0/12 - 6/12	3PVP-F6DS	3 3/4"	19 3/8"	23"	\$105.70
4", 0/12 - 6/12	4PVP-F6DS ❖	4 3/4"	19 3/8"	23"	\$119.70

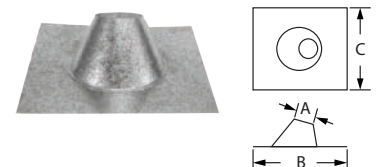

Storm Collar

Use to maintain a weather tight resistant seal between the pipe and the flashing.

SIZE	STOCK #	A	B	List Price
3"	3PVP-SC	3 5/8"	7 3/8"	\$11.34
4"	4PVP-SC	4 5/8"	8 1/8"	\$13.19

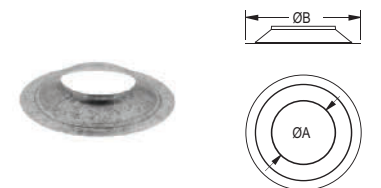

Vertical Cap

SIZE	STOCK #	List Price
3"	3PVP-VC	\$114.93
4"	4PVP-VC	\$122.60

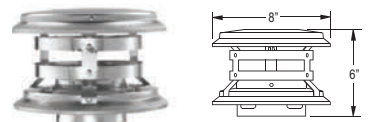

SOME BRANDS ARE ONLY AVAILABLE IN SELECTED AREAS, CONTACT YOUR REGIONAL SALES MANAGER FOR MORE INFO.

Pricing, model numbers and availability are subject to change without notice. Call for most current information.

Horizontal Cap w/ Tapered End

SIZE	STOCK #	List Price
3"	3PVP-HC2	\$87.02
4"	4PVP-HC2	\$98.38

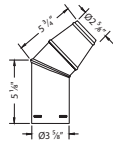

Square Horizontal Cap

SIZE	STOCK #	List Price
3"	3PVP-HSC	\$101.73
4"	4PVP-HSC	\$111.30

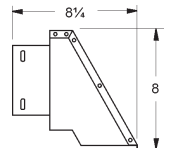

Ceiling Support/Wall Thimble Cover

Decorative cover for ceiling support boxes and wall thimbles. Use with reduction collar.

SIZE	STOCK #	List Price
3"-4"	3PVP-WTC	\$108.59

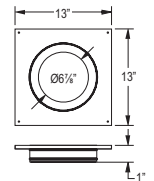

Reduction Collar

Reduces the center hole diameter in the ceiling support/wall thimble cover to fit 3" or 4" pipe.

SIZE	STOCK #	A	List Price
3"	3PVP-RC	3 3/4"	\$41.97
4"	4PVP-RC ❖	4 3/4"	\$41.97

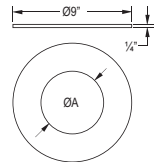

Chimney Adapter

Use to transition between pelletvent pro to existing chimney such as DuraTech, duraplus.

SIZE	STOCK #	List Price
3" – 6"	3PVP-X6	\$168.60
3" – 8"	3PVP-X8	\$208.23
4" – 6"	4PVP-X6 ❖	\$177.04
4" – 8"	4PVP-X8 ❖	\$214.32

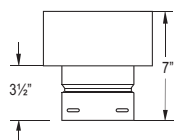

SOME BRANDS ARE ONLY AVAILABLE IN SELECTED AREAS, CONTACT YOUR REGIONAL SALES MANAGER FOR MORE INFO.

Pricing, model numbers and availability are subject to change without notice. Call for most current information.