

# Venting Components – B-Vent

## B-Vent

Installation Key			
1	DuraCap	14	Increaser
2	Storm Collar	15	Draft Hood Connector
3	Roof Flashing	16	Square Firestop Support
4	High-Wind Cap	17	Oval Pipe
5	Round Pipe	18	Oval to Round Adapter
6	Elbow	19	Oval Tee
7	Tee	20	Oval Tee Cap
8	Tee Cap	21	Oval Tee Support
9	Increaser Tee	22	Oval Firestop Spacer
10	Female Flex Adapter	23	DuraConnect II
11	Male Adapter	24	DuraFlex AL Length
12	Double-Wall Wye	25	DuraFlex Motar Sleeve
13	Pipe Collar	26	DuraFlex AL Coupling

### Applications

DuraVent's Type B Gas Vent system. Use w/ NG or liquid propane category I and draft hood equipped appliances, and appliances tested and listed to use Type B Gas Vent. Applications include: NG fireplaces, gas-fired furnaces, boilers, water heaters, and wall or space heating applications.

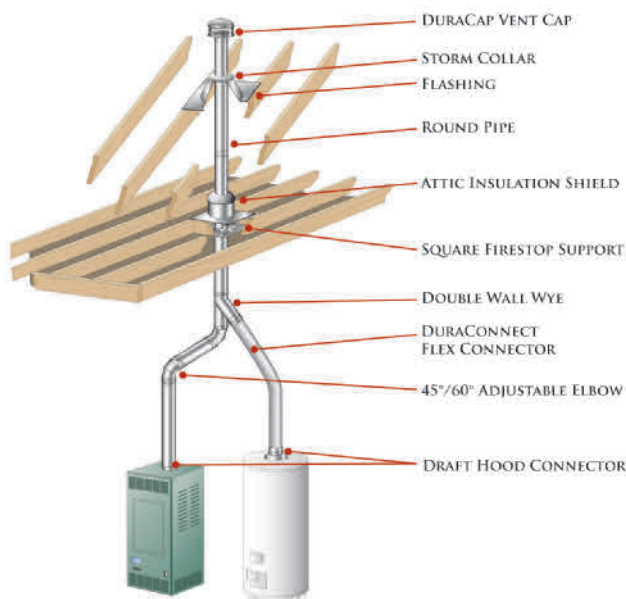

### Typical Installations

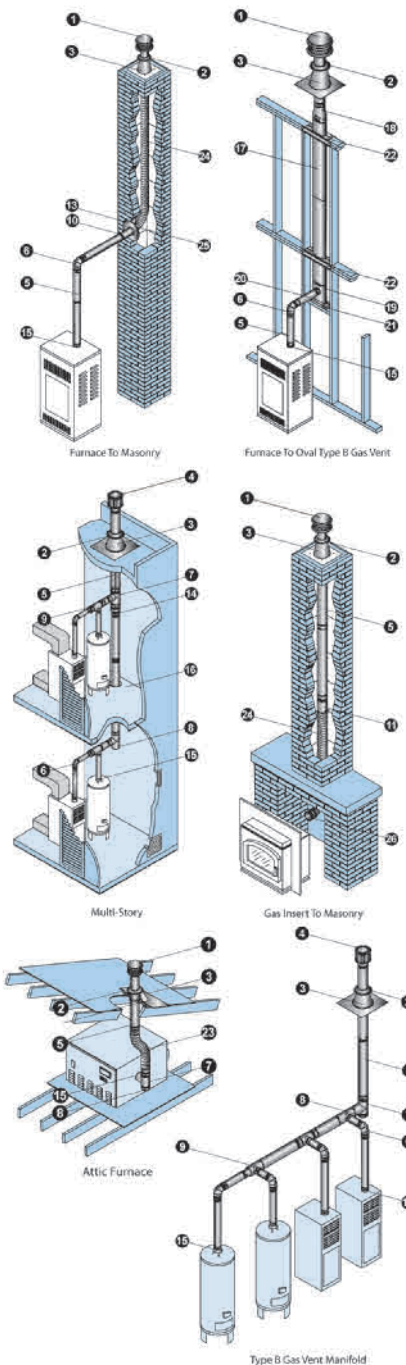

**SOME BRANDS ARE ONLY AVAILABLE IN SELECTED AREAS, CONTACT YOUR REGIONAL SALES MANAGER FOR MORE INFO.**  
Pricing, model numbers and availability are subject to change without notice. Call for most current information.

## Round Rigid Pipe

SIZE	LENGTH	STOCK #	LIST PRICE
3"	6"	3BV06	\$52.00
3"	12"	3BV12	\$24.68
3"	18"	3BV18	\$31.90
3"	24"	3BV24	\$39.64
3"	36"	3BV36	\$51.11
3"	48"	3BV48	\$68.04
3"	60"	3BV60	\$83.61
4"	6"	4BV06	\$31.02
4"	12"	4BV12	\$30.04
4"	18"	4BV18	\$36.61
4"	24"	4BV24	\$47.15
4"	36"	4BV36	\$64.84
4"	48"	4BV48	\$83.91
4"	60"	4BV60	\$101.45
5"	12"	5BV12	\$36.53
5"	18"	5BV18	\$43.22
5"	24"	5BV24	\$57.23
5"	36"	5BV36	\$77.07
5"	48"	5BV48	\$99.20
5"	60"	5BV60	\$117.14

SIZE	LENGTH	STOCK #	LIST PRICE
6"	6"	6BV06	\$41.64
6"	12"	6BV12	\$42.74
6"	18"	6BV18	\$49.40
6"	24"	6BV24	\$68.72
6"	36"	6BV36	\$89.27
6"	48"	6BV48	\$115.19
6"	60"	6BV60	\$135.00
7"	12"	7BV12 ❖	\$63.31
7"	18"	7BV18 ❖	\$78.59
7"	24"	7BV24 ❖	\$98.50
7"	36"	7BV36 ❖	\$130.31
7"	48"	7BV48 ❖	\$165.46
7"	60"	7BV60 ❖	\$202.16
8"	12"	8BV12	\$70.10
8"	18"	8BV18	\$79.93
8"	24"	8BV24	\$113.43
8"	36"	8BV36	\$144.91
8"	48"	8BV48	\$198.35
8"	60"	8BV60	\$230.40
10"	12"	10BV12	\$193.73
10"	18"	10BV18	\$210.47
10"	24"	10BV24	266.52
10"	36"	10BV36	\$297.90

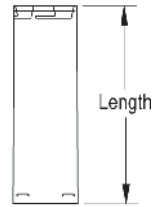

## Round Adjustable Pipe

SIZE	LENGTH	STOCK #	LIST PRICE
3"	3 1/2" – 10 1/2"	3BV12A	\$33.88
4"	3 1/2" – 10 1/2"	4BV12A	\$41.08
5"	3 1/2" – 10 1/2"	5BV12A	\$47.57
6"	3 1/2" – 10 1/2"	6BV12A	\$52.49
7"	3 1/2" – 10 1/2"	7BV12A ❖	\$66.84
8"	3 1/2" – 10 1/2"	8BV12A	\$79.76
10"		10BV18A	\$318.20

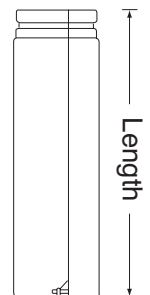

**SOME BRANDS ARE ONLY AVAILABLE IN SELECTED AREAS, CONTACT YOUR REGIONAL SALES MANAGER FOR MORE INFO.**  
 Pricing, model numbers and availability are subject to change without notice. Call for most current information.

❖ – Non Stock Special Order - NO RETURNS or CANCELLATIONS

**RMI Ph: 800-628-5044**

[raymurray.com](http://raymurray.com)

# Venting Components – B-Vent

## 90° Adjustable Elbow

Offsets obstructions as needed. Elbows (3"-8") swivel 360° at base. 90° elbow is adjustable from 0° to 90° in sizes 3'-10". Elbows must be supported when installed.

SIZE	STOCK #	LIST PRICE	A	B
3"	3BVL90	\$70.80	6 3/8"	4 11/16"
4"	4BVL90	\$83.81	6 3/8"	4 11/16"
5"	5BVL90	\$103.75	6 3/8"	4 11/16"
6"	6BVL90	\$119.82	6 3/8"	4 11/16"
7"	7BVL90 ❖	\$183.12	8"	6 1/2"
8"	8BVL90	\$184.18	8 1/4"	6 3/4"
10"	10BVL90 ❖	\$326.05	10 1/8"	9 5/8"

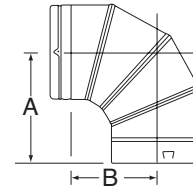

## 45°/60° Adjustable Elbow

Offsets obstructions as needed. Elbows swivel 360° at base. 45°/60° elbow is adjustable from 0° to 60°. Elbows must be supported when installed.

SIZE	STOCK #	LIST PRICE	OUTER	A	B
3"	3BVL45	\$40.74	3 1/2"	4 3/8"	4 11/16"
4"	4BVL45	\$49.44	4 1/2"	4 3/8"	4 11/16"
5"	5BVL45	\$56.81	5 1/2"	4 3/8"	4 11/16"
6"	6BVL45	\$68.72	6 1/2"	4 3/8"	4 11/16"

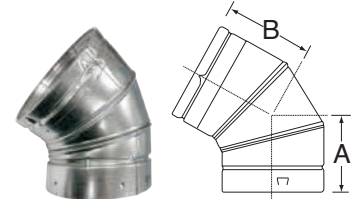

## 45° Elbow

SIZE	STOCK #	LIST PRICE	A	B	X	Y
7"	7BVL45 ❖	\$141.17	4 3/4"	4 3/4"	10 1/2"	10 1/2"
8"	8BVL45	\$116.60	4 3/4"	4 3/4"	10 1/4"	10 1/4"
10"	10BVL45	\$288.63	5 1/2"	5 3/4"	–	–

## Standard Tee

SIZE	STOCK #	LIST PRICE	A	B	C
3"	3BVT	\$89.83	6 5/8"	4 1/4"	4 1/4"
4"	4BVT	\$103.42	8 1/2"	4 3/4"	5"
5"	5BVT	\$115.24	9 1/2"	5 1/4"	5 1/2"
6"	6BVT	\$126.70	10 1/2"	5 3/4"	6"
7"	7BVT ❖	\$167.56	11 1/2"	6 1/4"	6 1/2"
8"	8BVT ❖	\$186.54	12 1/2"	6 3/4"	7"
10"	10BVT ❖	\$506.64			



**SOME BRANDS ARE ONLY AVAILABLE IN SELECTED AREAS, CONTACT YOUR REGIONAL SALES MANAGER FOR MORE INFO.**

Pricing, model numbers and availability are subject to change without notice. Call for most current information.

# Venting Components – B-Vent

## Tee Cap

SIZE	STOCK #	LIST PRICE
3"	3BVTC	\$7.25
4"	4BVTC	\$8.45
5"	5BVTC	\$10.43
6"	6BVTC ❖	\$11.62
7"	7BVTC ❖	\$22.99
8"	8BVTC ❖	\$25.05
10"	10BVTC ❖	\$46.86

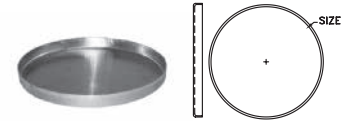

## Draft Hood Connector

Connects single wall vent to B vent.

SIZE	STOCK #	LIST PRICE	LENGTH
3"	3BVC	\$28.10	4 1/2"
4"	4BVC	\$30.39	4 1/2"
5"	5BVC	\$30.90	4 1/2"
6"	6BVC ❖	\$36.80	4 1/2"
7"	7BVC ❖	\$85.73	7"
8"	8BVC ❖	\$54.72	8"
10"	10BVC ❖	\$131.17	

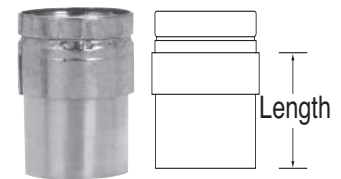

## Increaser

SIZE	STOCK #	LIST PRICE
3" x 4"	3BVX4 ❖	\$56.45
4" x 6"	4BVX6 ❖	\$59.11
5" x 6"	5BVX6 ❖	\$57.87

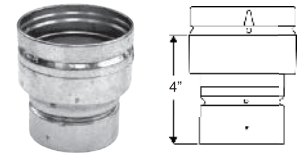

## Female Adapter

Used to adapt to DuraVent pipe towards appliance.

SIZE	STOCK #	LIST PRICE
3"	3BVAF	\$42.79
4"	4BVAF	\$43.78
5"	5BVAF	\$44.78
6"	6BVAF	\$45.77
7"	7BVAF	\$111.45
8"	8BVAF	\$178.31

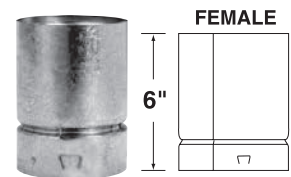

## Male Adapter

Male adapter used to adapt to DuraVent pipe toward termination.

SIZE	STOCK #	LIST PRICE
3"	3BVAM	\$59.44
4"	4BVAM	\$37.97
5"	5BVAM	\$40.51
6"	6BVAM	\$51.74
7"	7BVAM	\$178.31
8"	8BVAM	\$118.88

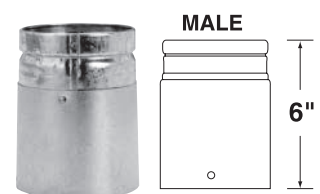

**SOME BRANDS ARE ONLY AVAILABLE IN SELECTED AREAS, CONTACT YOUR REGIONAL SALES MANAGER FOR MORE INFO.**

Pricing, model numbers and availability are subject to change without notice. Call for most current information.

# Venting Components – B-Vent

## Wall Band

Used to stabilize the pipe against a wall, must be installed just above Tee and every 6' there after.

SIZE	STOCK #	LIST PRICE	A
3"	3BVWS	\$41.45	3 1/2"
4"	4BVWS	\$47.07	4 1/2"
5"	5BVWS	\$52.70	5 1/2"

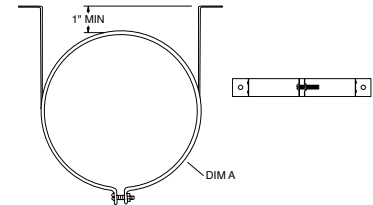
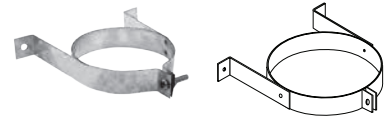

## Wall Support / Band Assembly

Used to stabilize the pipe against a wall, will support up to 35'.

SIZE	STOCK #	LIST PRICE	A
6"	6BVWSB	\$102.34	6 5/8"
7"	7BVWSB	\$122.54	7 5/8"
8"	8BVWSB	\$122.79	8 5/8"

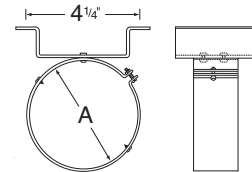

## Support Assembly

Use to support vent at ceiling level.

SIZE	STOCK #	LIST PRICE	A	Plate Dimensions
3"	3BVVS ❖	\$62.54	3 5/8"	17" x 10"
4"	4BVVS ❖	\$64.88	4 5/8"	17" x 10"
5"	5BVVS ❖	\$66.65	5 5/8"	17" x 12"
6"	6BVVS ❖	\$67.53	6 5/8"	17" x 12"
7"	7BVVS ❖	\$85.73	7 5/8"	17" x 14"
8"	8BVVS ❖	\$85.45	8 5/8"	17" x 14"

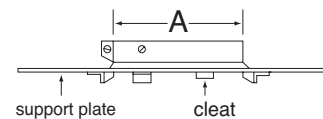

## Firestop Spacer

Used to protect combustible materials where pipe passes through a ceiling or wall.

SIZE	STOCK #	LIST PRICE	A	B
3"	3BVFS ❖	\$18.11	5 1/2"	5 1/2"
4"	4BVFS	\$18.11	6 1/2"	6 1/2"
5"	5BVFS ❖	\$18.11	7 1/2"	7 1/2"
6"	6BVFS	\$18.11	8 1/2"	8 1/2"
7"	7BVFS ❖	\$64.30	9 1/2"	9 1/2"
8"	8BVFS	\$34.90	10 1/2"	10 1/2"
10"	10BVFS	\$156.33		

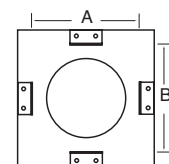
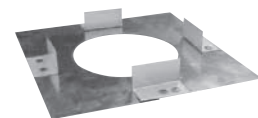

**SOME BRANDS ARE ONLY AVAILABLE IN SELECTED AREAS, CONTACT YOUR REGIONAL SALES MANAGER FOR MORE INFO.**

Pricing, model numbers and availability are subject to change without notice. Call for most current information.

# Venting Components – B-Vent

## Pipe Collar

Use for decorative purpose.

SIZE	STOCK #	LIST PRICE	A	B	C
3"	3BVPC	\$10.49	3 5/8"	10 11/16"	3 9/16"
4"	4BVPC	\$10.64	4 5/8"	10 11/16"	3 1/16"
5"	5BVPC	\$11.06	5 5/8"	10 11/16"	2 9/16"
6"	6BVPC	\$13.94	6 5/8"	10 11/16"	2 1/16"
7"	7BVPC ❖	\$21.72	7 5/8"	11 1/4"	1 3/4"

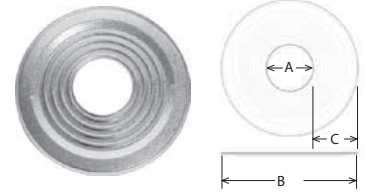

## Wall Thimble

Use for through-the-wall system to provide clearances for vent from combustibles.

SIZE	STOCK #	LIST PRICE	A	B
3"	3BVWT	\$47.08	3 5/8"	7"
4"	4BVWT	\$48.38	4 5/8"	8 1/4"
5"	5BVWT	\$53.79	5 5/8"	9 1/2"
6"	6BVWT	\$81.73	6 5/8"	10 3/4"
7"	7BVWT ❖	\$73.36	7 5/8"	11"
8"	8BVWT	\$82.85	8 5/8"	12 1/2"

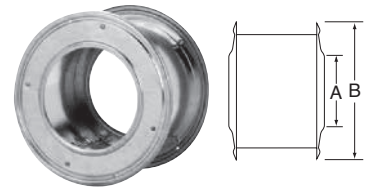

## Storm Collar

Use to maintain a weather tight resistant seal to pipe above roof line.

SIZE	STOCK #	LIST PRICE	A	B
3"	3BVSC	\$6.88	1 9/16"	6 5/8"
4"	4BVSC	\$8.36	1 9/16"	7 5/8"
5"	5BVSC	\$16.82	1 9/16"	8 5/8"
6"	6BVSC	\$17.60	1 9/16"	9 5/8"
7"	7BVSC ❖	\$20.67	1 9/16"	10 3/4"
8"	8BVSC	\$21.53	1 9/16"	11 3/4"
10"	10BVSC	\$31.78		

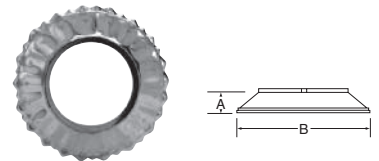

## Attic Insulation Shield

SIZE	STOCK #	LIST PRICE	A	B	C
3" - 4"	3BVIS ❖	\$158.73	6 3/4"	7 3/16"	9 1/4"
5" - 6"	5BVIS ❖	\$181.30	8 3/4"	8 15/16"	11"
7" - 8"	7BVIS ❖	\$242.45	10 3/4"	10 5/16"	13"

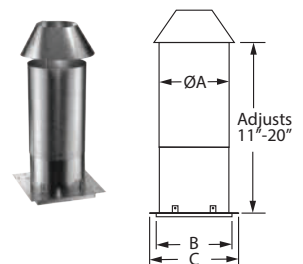

**SOME BRANDS ARE ONLY AVAILABLE IN SELECTED AREAS, CONTACT YOUR REGIONAL SALES MANAGER FOR MORE INFO.**

Pricing, model numbers and availability are subject to change without notice. Call for most current information.

❖ - Non Stock Special Order - NO RETURNS or CANCELLATIONS

**RMI Ph: 800-628-5044**

**raymurray.com**

**395**

# Venting Components – B-Vent

## Adjustable Roof Flashing

SIZE	STOCK #	LIST PRICE	A	B	C	D
3"	3BVF	\$27.33	3 1/2"	14 7/8"	12 1/4"	6 11/16"
4"	4BVF	\$30.85	4 1/2"	16"	13 1/4"	7 3/4"
5"	5BVF	\$48.98	5 1/2"	16 15/16"	14 1/4"	8 7/8"
6"	6BVF	\$67.60	6 1/2"	18"	15 1/4"	10"
7"	7BVF ❖	\$84.00	7 1/2"	19 1/8"	16"	11 1/8"
8"	8BVF	\$88.98	8 1/2"	21 1/4"	16 15/16"	12 1/4"

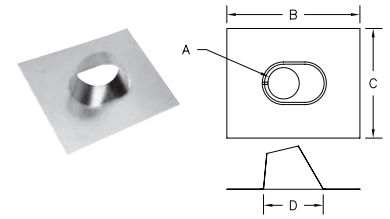

## Adjustable Steep Roof Flashing

SIZE	STOCK #	LIST PRICE	A	B	C	D
3"	3BVF <sup>SR</sup> ❖	\$75.98	3 1/2"	18"	15 1/4"	10 1/4"
4"	4BVF <sup>SR</sup> ❖	\$79.95	4 1/2"	19 1/8"	16"	11 1/8"
5"	5BVF <sup>SR</sup> ❖	\$88.98	5 1/2"	20 1/4"	16 15/16"	12 1/4"
6"	6BVF <sup>SR</sup>	\$114.70	6 1/2"	24 1/4"	20"	15 5/8"
7"	7BVF <sup>SR</sup> ❖	\$138.57	7 1/2"	24 1/4"	20"	15 5/8"
8"	8BVF <sup>SR</sup> ❖	\$178.93	8 1/2"	25"	19 1/2"	17 1/8"

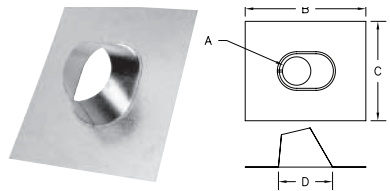

## Vertical DuraCap

SIZE	STOCK #	LIST PRICE	A	B
3"	3BVDC	\$38.68	8"	5"
4"	4BVDC	\$40.93	8"	5"
5"	5BVDC	\$55.80	11"	7 1/2"
6"	6BVDC	\$69.75	11"	7 1/2"
7"	7BVDC ❖	\$83.83	15"	7 1/4"
8"	8BVDC	\$97.96	15"	7 1/4"



## Vertical High-Wind Cap

SIZE	STOCK #	LIST PRICE	A	B
3"	3BVVTH	\$43.27	7 1/2"	7 1/4"
4"	4BVVTH	\$46.32	8 1/2"	8 1/4"
5"	5BVVTH	\$61.82	9 1/2"	9 3/8"
6"	6BVVTH	\$80.12	10 1/2"	9 1/4"
7"	7BVVTH ❖	\$126.31	11 1/2"	11 3/4"
8"	8BVVTH	\$125.14	12 1/2"	12 3/4"
10"	10BVVT	\$338.32	17 1/2"	16"

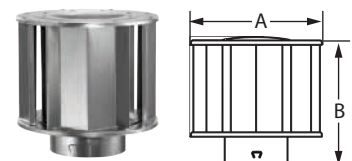

**SOME BRANDS ARE ONLY AVAILABLE IN SELECTED AREAS, CONTACT YOUR REGIONAL SALES MANAGER FOR MORE INFO.**

Pricing, model numbers and availability are subject to change without notice. Call for most current information.